



Residential Gas Water Heaters

Operating, installation and service manual

Standard Residential Gas Water Heater
with vaporshield Technology

Residential 30, 40 and 50 Gallons

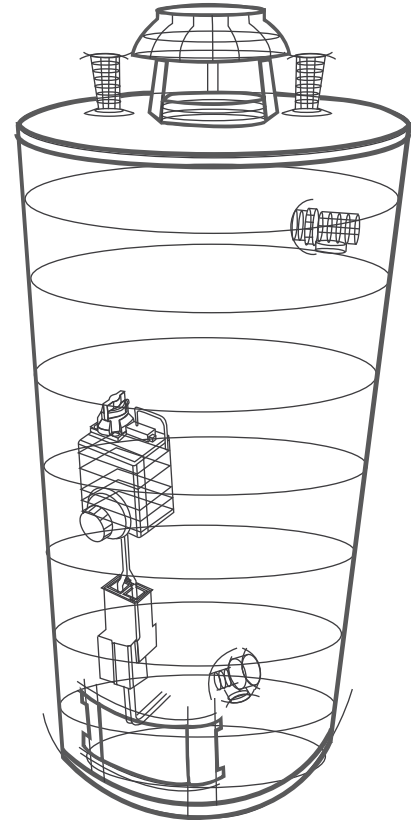

⚠ WARNING: If the information in these instructions is not followed exactly, a fire or explosion may result causing property damage, personal injury or death.

Do not store or use gasoline or other flammable vapors and liquids in the vicinity of this or any other appliance

WHAT TO DO IF YOU SMELL GAS

- Do not try to light any appliance
- Do not touch any electrical switch, do not use any phone in your building
- Immediately call your gas supplier from a neighbor's phone. Follow the gas supplier's instructions.
- If you can not reach your gas supplier, call the fire department

Installation and service must be performed by a qualified installer, service agency or the gas supplier.

THIS WATER HEATER SHALL NOT BE INSTALLED IN BATHROOMS, BEDROOMS, OR ANY OCCUPIED ROOM NORMALLY KEPT CLOSED.

VAPORSHIELD® Technology Gas Water Heaters meet the new ANSI Z2.1.1.0.1 standard that deals with the accidental or unintended ignition of Flammable Vapors, such as those emitted by gasoline.

⚠ WARNING: This water heater is equipped for one type of gas only. Check the data plate near the gas control valve for the correct gas. **DO NOT USE THIS WATER HEATER WITH ANY GAS OTHER THAN THE ONE LISTED ON THE DATA PLATE.** Failure to use the correct gas can cause problems which can result in DEATH, SERIOUS BODILY INJURY OR PROPERTY DAMAGE. If you have any questions or doubts consult your gas supplier or gas company. Water heaters for bottled, propane or liquefied petroleum gas (LPG) are different from natural gas models. A natural gas heater will not function safely on bottled, propane or liquefied petroleum gas (LPG) and no attempt should be made to convert a heater from natural gas to any other gas.

INSTALLER:

1. Affix these instructions to or adjacent to water heater.
2. Before leaving premises: REVIEW this operation, installation and service manual to be sure heater has been installed correctly make sure unit is started and operated for one complete cycle and water temperature is acceptable to the consumer.

OWNER:

1. Retain these instructions and warranty for future reference.

All technical and warranty questions should be directed to the local dealer from whom the water heater was purchased. If you are unsuccessful please write to the company listed on the warranty or data plate which came with your water heater.



GENERAL SAFETY



⚠ WARNING

Read and understand instruction manual and safety messages before installing, operating or servicing this water heater.
 Failure to follow instructions and safety messages could result in death or serious injury.
 Instruction manual must remain with water heater.

⚠ DANGER

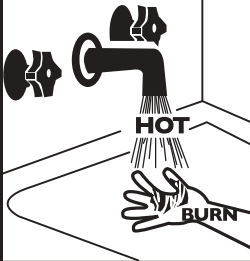

Water temperature over 125°F (52° C) can cause severe burns instantly resulting in severe injury or death.
 Children, the elderly, and the physically or mentally disabled are at highest risk for scald injury.
 Feel water before bathing or showering.
 Temperature limiting valves are available.
 Read instruction manual for safe temperature setting.



⚠ WARNING

Fire or Explosion Hazard

- Do not store or use gasoline or other flammable vapors and liquids in the vicinity of this or any other appliance.
- Avoid all ignition sources if you smell gas.
- Do not expose water heater control to excessive gas pressure
- Use only gas shown on rating plate.
- Maintain required clearances to combustibles.
- Keep ignition sources away from faucets after extended periods of non-use.



Read instruction manual before installing, using or servicing water heater.





⚠ WARNING

Fire Hazard

For continued protection against risk of fire:

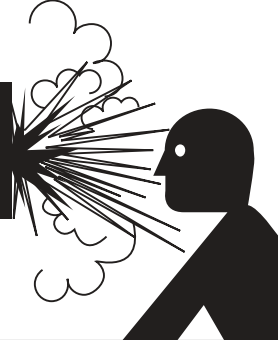
- Do not install water heater on carpeted floor.
- Do not operate water heater if flood damaged.



⚠ WARNING

Explosion Hazard

- Overheated water can cause water tank explosion.
- Properly sized temperature and pressure relief valve must be installed in opening provided.

CAUTION

Improper installation and use may result in property damage

- Do not operate water heater if flood damaged.
- Inspect and replace anode (see page 18).
- Install in location with drainage.
- Fill tank with water before operation.
- Be alert for thermal expansion.

Refer to instruction manual for installation and service.

TABLE OF CONTENTS

General Safety	A
Table of contents, installation information	B
Consumer responsibilities	1
Location clearances from combustible construction	2
Installation check list	3,4
Typical installation	5
Air supply, all air from inside the building, all air from outside the building	6
Mechanical exhausting and fireplaces, drafthood	7,8
Venting, water piping, gas piping installation, installations safety warning - L.P. units	8
Temperature and pressure relief valve	8
Potable water system / High Altitude Information	9
Solar installation, insulation blanket	10
Safety instructions, lighting instructions	11
Gas supply, gas piping installation, pressure warning	12
Piezo electric igniter system, testing igniter system, removing and replacing gas control valve/thermostat	13
Replacing the high temperature cut off switch assembly	13
Thermocouple replacement, Instructions	14
Burner maintenance/replacement	15
Draining and flushing interior of tank	16
Venting system inspection, tampering	
Emergency shut down condensation, exposure to water	17
Hydrogen gas warning, L.P. models, out of fuel, anode, water heater sounds, qualified service persons	18
Troubleshooting check list	19,20
Repair parts illustration	21
Ordering parts and service	22

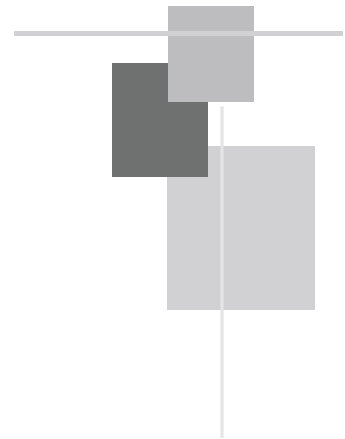

⚠ WARNING
**IMPROPER INSTALLATION,
 ADJUSTMENT, ALTERATION,
 SERVICE OR MAINTENANCE
 CAN CAUSE INJURY, DEATH OR
 PROPERTY DAMAGE READ
 AND REFER TO THIS MANUAL.**

Please complete the following information at the time of installation. This should be retained and presented along with the warranty in the event a claim is necessary.

MODEL NUMBER: _____ TYPE OF GAS: _____

SERIAL NUMBER: _____

INSTALLATION ADDRESS: _____

DATE OF INSTALLATION: _____

THIS WATER HEATER HAS BEEN INSTALLED IN ACCORDANCE WITH THESE INSTALLATION INSTRUCTIONS AND LOCAL CODE REQUIREMENTS ON: _____

DATE



CONSUMER RESPONSIBILITIES

THIS MANUAL HAS BEEN PREPARED TO ACQUAINT YOU WITH THE INSTALLATION, OPERATION AND MAINTENANCE OF YOUR GAS WATER HEATER AND TO PROVIDE IMPORTANT SAFETY INFORMATION.

WE URGE YOU TO READ ALL INSTRUCTIONS THOROUGHLY before attempting installation or operation of your water heater. Keep these instructions for future reference.

The manufacturer of this water heater will not be liable for any damages caused by failure to comply with the installation and operating instructions outlined on the following pages. These instructions are a guide for the correct installation of your water heater. If you lack the necessary skills required or have difficulty following the directions, you should not proceed but get help from a qualified person for that part of the installation you do not understand. Failure to follow this warning can result in an incorrect installation that can result in **DEATH, INJURY OR PROPERTY DAMAGE**.

This water heater is design – certified by CSA International as a non – direct vented water heater , which takes its combustion air, either from the installation area or from air ducted to the unit from outside.

This appliance must be installed in accordance with local codes or, in the absence of local codes, the National Fuel Gas Code, ANSI Z223.1/NFPA 54 or CSA B149.1, Natural Gas and Propane Installation Codes.

This code is available from the following:

American Gas Association
400 North Capitol, St; NW
Washington D.C. 20001-0000
E-mail AGA.org

National Fire Protection Agency
1 Batterymarch Park
Quincy, MA 02269
Check your local phone listings for the local authorities having jurisdiction over your installation.



Important WARNINGS: Do not use this appliance if any part has been under water.

Immediately call a qualified service technician. Water heaters subjected to flood conditions, or anytime the gas controls, main burner or pilot have been submerged in water; require replacement of the entire water heater.

UNPACKING THE Water Heater

⚠️ WARNING

Use two or more people to move and install water heater, unless proper handling equipment is utilized. Failure to do so can result in back or other injury.

Important: Do not remove any permanent instructions, labels, or the data label from outside of the water heater or on the inside of panels.

Remove exterior packaging and place installation components aside.

Inspect all parts for damage prior to installation and startup.

Completely read all instructions before attempting to assemble and install this product.

LOCATION

⚠️ WARNING

- This water heater may not be installed in a mobile home.
- Location selection should be as close to the stack or chimney as practical and as centralized with the piping system as possible.
- Water heater should be located in an area not subject to freezing temperatures.
- The water heater should be located so that the controls and drain are easily accessible (at least 24 inches of open space of the water heater).
- The heater should be located in such manner that if the tank or any connection should leak, the flow will not cause damage to the structure.
- A suitable drain pan must be installed under the heater. Such pans must have a minimum length and width of at least two inches greater than the diameter of the heater, and must be piped to an adequate drain. The pan must not restrict combustion air flow (Figure 1)

FIGURE 1

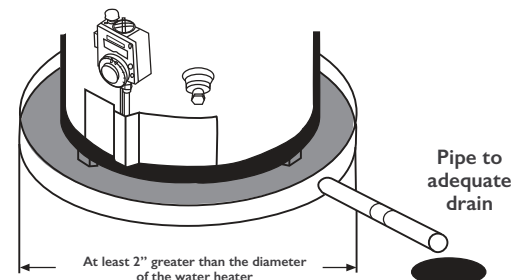

WARNING

When this heater is installed directly on carpeting, carpeting must be protected by a metal or wood panel beneath the appliance extending beyond the full width and depth if the appliance is installed in an alcove or closet, the entire floor must be covered by the panel.

FAILURE TO HEED THIS WARNING MAY RESULT IN FIRE HAZARD.

WARNING

Minimum clearances between the water heater and combustible construction are 0" at the sides and rear, 6" at the front, and 6" from the vent pipe. Clearance from the top of the jacket is 12" on most models, refer to the label attached adjacent to the gas control valve on the water heater. When 12" top clearance is used, a minimum of 6" must be provided between the vent pipe and the ceiling if an elbow is used on the draft hood.

**TOP VIEW
OF CLOSET
WITHOUT DOOR**

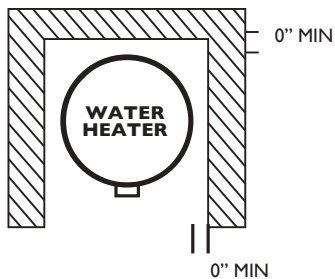

**TOP VIEW
OF CLOSET
WITH DOOR**

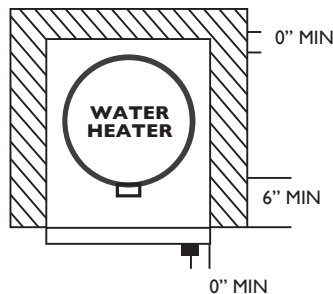

FIGURE 2: This may be used as a reference guide to locate the specific clearance locations. A minimum of 24 inches front clearance should be provided for inspection and serving.

RESIDENTIAL AREA WHICH MAY NOT BE SUITABLE FOR HEATER INSTALLATION would include those areas where flammable liquids (such as gasoline, solvents, liquified propane or butane, etc.) or other substances (such as adhesive, etc.) all of which emit Flammable Vapors, may be improperly stored or used. Because of natural air movement in a room or other enclosed space, Flammable Vapors can be carried some distance from where their liquids are being used or stored.

The gas water heater pilot flame or main burner can ignite such vapors. The resulting flash-back and fire can cause death or serious burns to anyone in the area, as well as property damage. Even though this water heater is a Flammable Vapors ignition resistant water heater and is designed to reduce the chances of Flammable Vapors being ignited, gasoline and other flammable substances should never be stored or used in the same vicinity or area containing or gas water heater or other flammable or spark producing appliances

NOTE: HEATER SHALL BE LOCATED OR PROTECTED SO IT IS NOT SUBJECT TO PHYSICAL DAMAGE BY MOVING VEHICLES OR AREA FLOODING

FIGURE 3:

Typical installation in residential garages. (Drawing copyright by the American Gas Association. Used by permission of the copyright holder.)

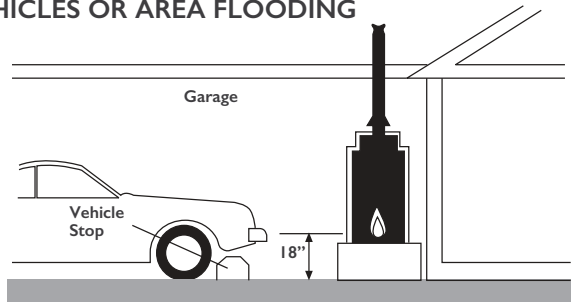

Do not locate the water heater near an air moving device. The operation of air moving devices such as exhaust fans, ventilation system, clothes dryers, fireplaces, etc., can affect proper operation of the water heater. Special attention must be given to conditions these devices may create. Low Reversal of flue gases may cause an increase of carbon monoxide inside of the dwelling.

This water heater, like all gas appliances will perform better if dirt and debris are prevented from accumulating on the floor in front of the water heater where dust and lint can be drawn into the burner.

If the water heater is located in an area that is subjected to lint, dirt and oil it may be necessary to periodically clean the pilot air intake screen in front of burner to prevent it from becoming blocked and shutting down the water heater, this can be done with a cloth, a small brush, or a vacuum nozzle.

A water heater cannot operate properly without the correct amount of air for combustion. Do not install in a confined area such as closet, unless you provide air as shown in Figure 3. Never obstruct the flow of ventilation air. If you have any doubts or questions at all, call your gas supplier. Failure to provide the proper amount of combustion air can result in a fire or explosion and cause death, serious bodily injury, or property damage.

Follow all the local and state codes. Or, in the absence of local and state codes, the "National Fuel Gas Code", ANSI Z223.1 (NFPA 54)- latest edition to properly install the system.

Failure to do so can result in death, injury or carbon monoxide poisoning.

WARNING	
Breathing Hazard- Carbon Monoxide Gas	
	<ul style="list-style-type: none"> • Install water heater in accordance with the instruction manual and NFPA54. • To avoid injury, combustion and ventilation air must be taken from outdoors. • Do not place chemical vapor emitting products near water heater.
Breathing carbon monoxide can cause brain damage or death. Always read and understand instruction manual.	

INSTALLATION CHECK LIST*

*This is presented for ease of reference. It is not comprehensive. All instructions and warnings must be read and adhered to.

A. Heater Location

- Close to area of vent.
- Indoors and protected from freezing temperatures (Refer to Water Piping Section).
- Proper clearance from combustible surfaces observed and heater not installed directly on carpeted floor.
- Sufficient fresh air supply for proper operation of heater.
- Air supply free of corrosive elements and flammables vapors.
- Provisions made to protect area from water damage.
- Sufficient room to service heater.

B. Combustion air supply and ventilation

- Sufficient fresh air supply for proper water heater operation.
- Fresh air not taken from areas that contain negative pressure producing devices such as exhaust fans, fireplaces, etc.
- Fresh air supply free of corrosive elements and flammables vapors.
- Fresh air openings sized correctly with consideration given to the blocking effect of louvers and grilles.
- Ductwork bringing in combustion air is at least the same cross-sectional area as the openings.

C. Gas supply

- Gas supply same as the type of gas listed on the data plate.
- Gas line equipped with shut-off valve, union and drip leg (Figure 4 - Page 4).
- Approved pipe joint compound used
- Soap and water solution used to check all connections and fittings for possible gas leaks.

D. Venting (Page 6)

- Draft diverter properly installed.
- Vent connector(s) securely fastened together with screws.
- Vent connector(s) at least 6" from combustible material.
- Flue baffle engaged in slots if provided in flue tube.

E. Water system piping

- Temperature and pressure relief valve is properly installed with a discharge line run to an open drain and protected from freezing.
- All piping properly installed and free of leaks.
- Heater completely filled with water.
- Closed system pressure build-up precautions installed.
- Tempering valve installed per manufacturer's instructions.

FIGURE 2B

Other than direct vent terminal clearances
(See Clause 4.33.2)

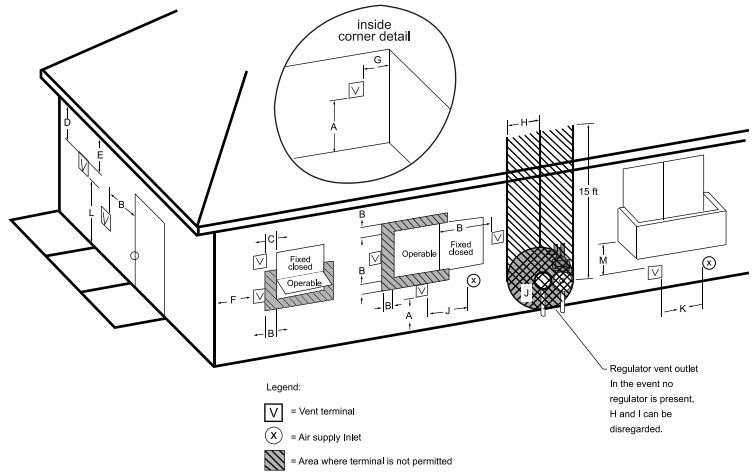

NOTE: If local adopted installation codes specify clearances different than those illustrated, then the most stringent clearance shall prevail.

TERMINAL CLEARANCES (USES ROOM AIR COMBUSTION)

A	Clearance above grade, veranda, porch, deck, or balcony	12 in. (30 cm)	I	Clearance to regulator vent outlet	4 ft. (1.2 m) below or to side of opening; 1 ft (300 mm) above opening
B	Clearance to window or door that may be opened	4 ft. (1.2 m) below or to side of opening; 1 ft (300 mm) above opening	J	Clearance to a non-mechanical air supply inlet into building or combustion air inlet to any other appliance	4 ft. below or to side of opening; 1 ft (300 mm) above opening
C	Clearance to permanently closed window	0 in.	K	Clearance to a mechanical air supply inlet	3 ft. (91 cm) above if within 10 ft. (3 m) Horizontally
D	Vertical clearance to ventilated soffit located above the terminal within a horizontal distance of 2 feet (61 cm) from the center line of the terminal	12 in. †	L	Above paved sidewalk or paved driveway located on public property	7 ft. (2.13m) for mechanical draft systems (category I appliances); vents for category II and IV appliances cannot be located above public walkways or other areas where condensate or vapor can cause a nuisance or hazard
E	Clearance to unventilated soffit	12 in.	M	Clearance under veranda, porch, deck, or balcony	12 in. ‡
F	Clearance to outside corner	24 in.			
G	Clearance to inside corner	18 in.			
H	Clearance to each side of center line extended above meter/regulator assembly	3 ft. (91 cm) within a height 15 feet (4.5 m) above the meter assembly			

TYPICAL INSTALLATION

NOTE:

1. When connecting more than one appliance into a common chimney, the water heater's vent connector must enter the chimney above all other vent connectors.
2. Do not vent a natural draft appliance (such as this heater) and a forced draft or power vent appliance into the same chimney.
3. Vent Termination Horizontal 12" min. above grade/snow level.

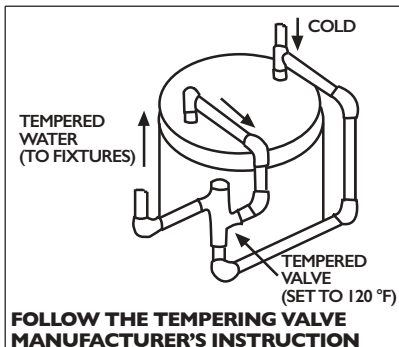
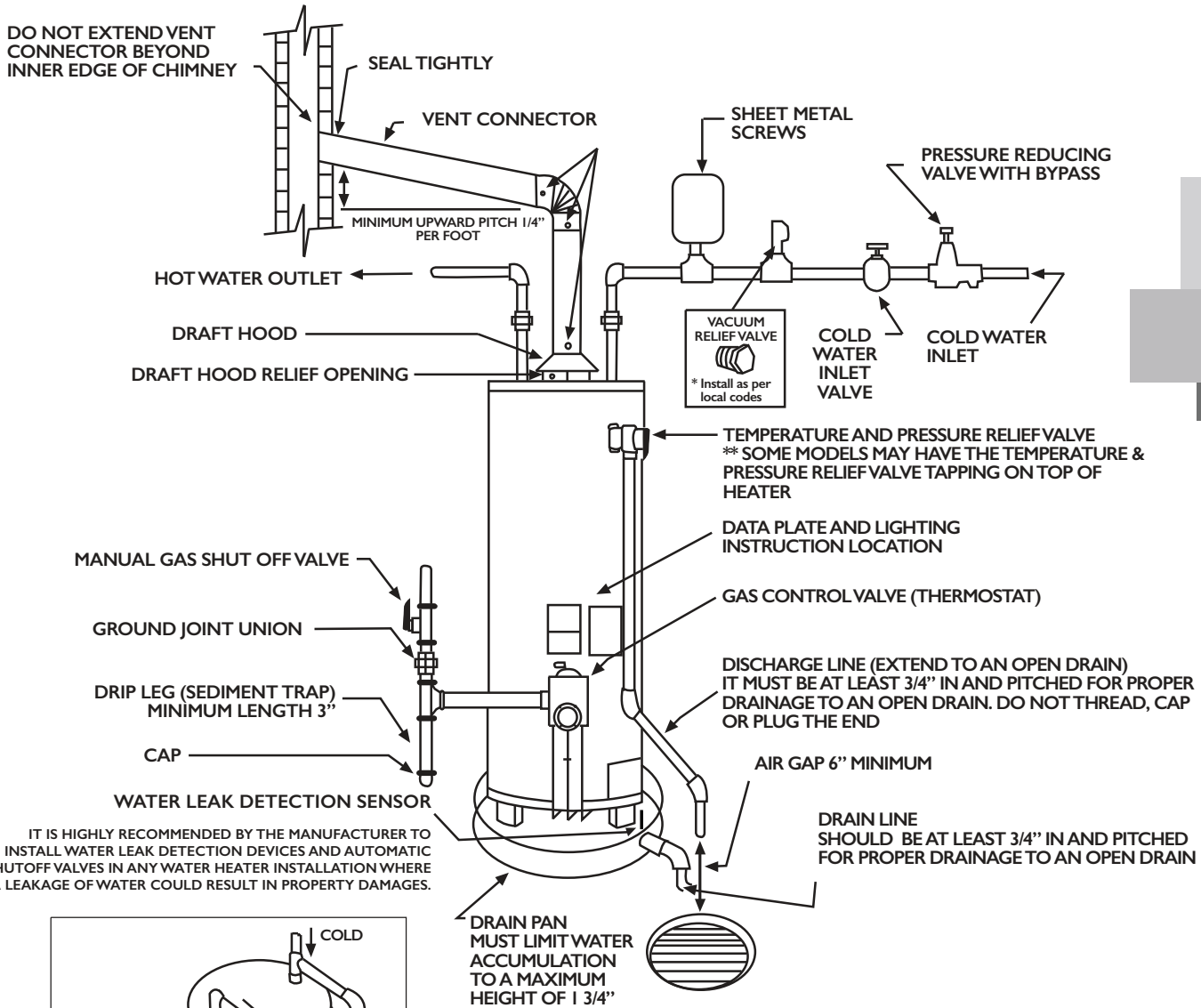
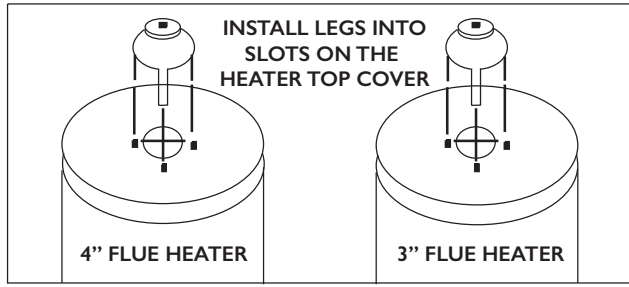

FIGURE 4

State of California Note:
The water heater must be braced, anchored, or strapped to avoid moving during an earthquake. Contact local utilities for code requirement in your area or call 1-888-883-0788 and request instructions.

PIPING MUST MEET ALL LOCAL CODE REQUIREMENTS.
NOTE: Water heater must be installed level.

AIR SUPPLY

ALL AIR FROM OUTDOORS 6

IMPORTANT: Air for combustion and ventilation must not come from a corrosive atmosphere. Any failure due to corrosive elements in the atmosphere is excluded from warranty coverage.

The following types of installation (not limited to the following) will require outdoor air for combustion due to chemical exposure and may reduce but not eliminate the presence of corrosive chemicals in the air.

- Beauty shops
- Photo processing labs
- Buildings with indoor pools
- Water heaters installed in laundry, lobby, or craft rooms
- Water heaters installed in chemical storage areas

Combustion air must be free of acid-forming chemicals such as sulfur, fluorine, chlorine. These elements are found in aerosol sprays, detergents, bleaches, cleaning solvents, air fresheners, paint and varnish removers, refrigerants, and many other commercial or household products. When burned, vapors from these products form highly corrosive acid compounds. These products should not be stored or used near the water heater or air inlet.

Combustion and ventilation air requirements are determined by the location of the water heater. The water heater may be located in either an open (unconfined) area or in a confined area or small enclosure, such as a closet or small room. Confined spaces are areas with less than 50 sq ft.

ALL AIR FROM INSIDE THE BUILDING

The confined space shall be provided with two permanent openings communicating directly with an additional room(s) of sufficient volume so that the combined volume of all spaces meets the criteria for an unconfined space shall be considered in making this determination. Each opening shall have a minimum free area of 1 square inch per 1,000 BTU per hour of the total input rating of all gas utilization equipment in the confined space, but not less than 100 square inches.

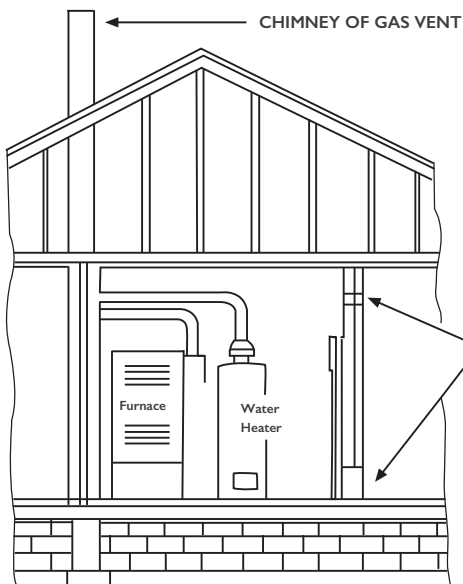
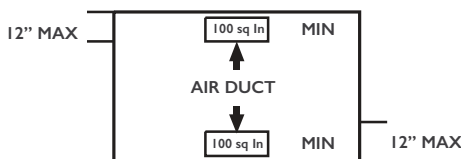

FIGURE 5

One opening shall be within 12 inches of the top and one within 12 inches of the bottom of the enclosure.



The confined space shall be provided with two permanent openings, one commencing within 12 inches of the top and one commencing within 12 inches of the bottom of the enclosure. The openings shall communicate directly, or by ducts, with the outdoors or spaces (crawl or attic) that freely communicate with the outdoors.

When directly communicating with the outdoors, each opening shall have a minimum free area of 1 square inch per 4,000 BTU per hour of total input rating of all equipment in the enclosure (Figure 6).

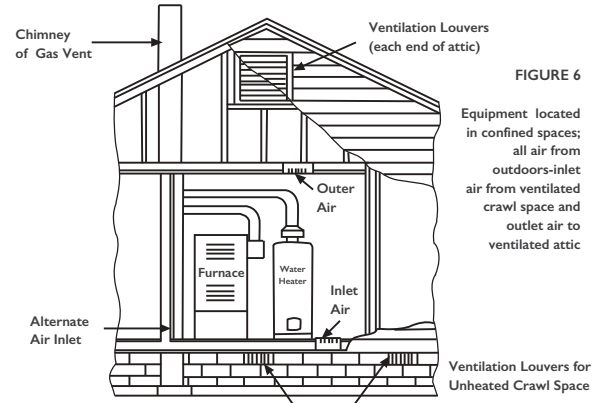

FIGURE 6

When communicating with the outdoors through vertical ducts, each opening shall have a minimum free area of 1 square inch per 4,000 BTU per hour of total input rating of all equipment in the enclosure (Figure 7).

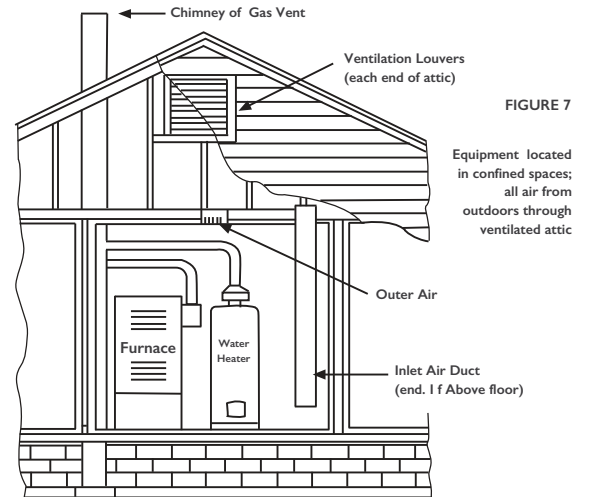

FIGURE 7

1. When communicating with the outdoors through horizontal ducts, each duct opening shall have a minimum free area of 1 square inch per 2,000 BTU per hour of total input rating of all equipment in the enclosure (Figure 8).

When ducts are used, they shall be of the same cross-sectional area as the free area of the openings to which they connect. The minimum dimension of rectangular air ducts shall not be less than 3 inches. For other combustion and ventilation air openings, refer to the National Fuel Gas Code ANSI Z223.1.*

NOTE: If the equipment room is located against an outside wall and the air openings communicate directly with the outdoors, each opening shall have a free area of not less than one square inch per 4,000 BTU per hour of the total input rating of all equipment in the enclosure.

Illustrations for Figures 5-8 copyright by the American Gas Association. Used by permission of the copyright holder.

DISCHARGE OF PURGED GASES

When removing purged gases from a piping system, care should be taken to not create hazardous conditions, such as discharging the gases into a confined area or in an area which contains an ignition source.

VENT PIPE SYSTEM

The water heater must be connected to the chimney. The vent pipe from the heater to the chimney (vent connector) must be no less than the diameter of the draft hood outlet on the heater and should slope upward to the chimney at least 1/4 inch per linear foot. Don't cover non-metallic vent pipe and fittings with thermal insulation.

Due to great variances in installations, unforeseeable by the manufacturer of the water heater, increased size vent connectors and pipes may be necessary for proper venting.

Consult your local utility. They will aid you in determining the proper venting for your heater from the vent tables in the American National Standard Z223.1 (NFPA 54) "National Fuel Gas Code".

There are various types of vent dampers currently available. Some of these vent dampers are certified by the Canadian Standard Association Laboratories. The certifications apply to the vent damper device only and do not mean they are certified for use on this water heater. The use of these devices is not permitted by the manufacturer of this water heater.

WARNING

VENTING

This water heater uses a non-direct, single-pipe vent system to remove exhaust gases created by the burning of fossil fuels. Air for combustion is taken from the immediate water heater location or is ducted in from the outside (see "Combustion Air Supply and Ventilation").

This water heater must be properly vented for the removal of exhaust gases to the outside atmosphere. Correct installation of the vent pipes system is mandatory for the proper and efficient operation of this water heater and is an important factor in the life of the unit.

The vent pipe must be installed according to all local and state codes or, in the absence of local and state codes, the "National Fuel Gas Code", ANZI Z223.1 (NFPA 54)-latest edition. The vent pipe installation must not be obstructed so as to prevent the removal of exhaust gases to the outside atmosphere.

UL approved fuel gas and carbon monoxide (CO) detectors are recommended in all applications and should be installed using the manufacturer's instructions and local codes, rules, or regulations.

Important: If you lack the necessary skills required to properly install this venting system, you should not proceed, but get help from a qualified service technician.

MECHANICAL EXHAUSTING AND FIREPLACES

The operation of air-moving devices such as exhaust fans, ventilation system, clothes dryers, fireplaces, etc., can affect the proper operation of gas utilization equipment.

Consequently, special attention must be given to conditions these devices may create to avoid unsatisfactory operation of the equipment.

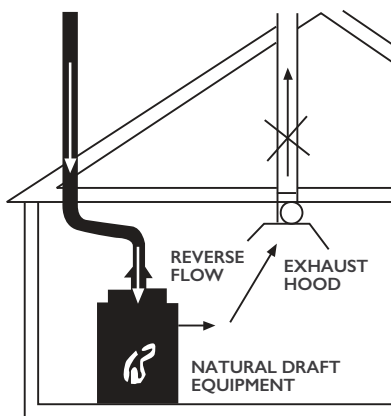

POTENTIAL HAZARDOUS DOWNDRAFT OPERATION

- EXHAUST FANS
- VENTILATION SYSTEM
- CLOTHES DRYERS
- FIREPLACES
- OTHERS

FIGURE 9

Chimney of Gas Vent →

FIGURE 8

Equipment located in confined spaces; all air from outdoors.

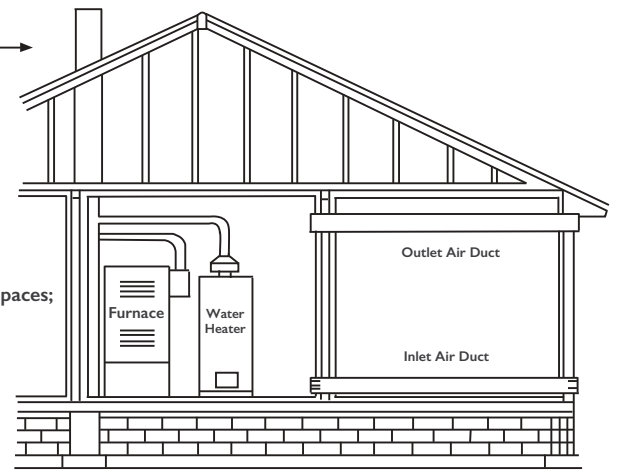

DRAFTHOOD INSTALLATION

Align the legs of the draft hood with the slots provided. Insert the legs on the slots as shown in Figure 10. Do not alter the draft hood in any way.

If you are replacing an existing water heater, be sure to use the new draft hood supplied with the water heater. Secure draft hood by placing leg tabs into top jacket openings.



FIGURE 10

VENT PIPE SIZE

It is important that you follow the guidelines in these instructions for sizing a vent pipe system. If a transition to a larger vent size is required, the vent transition connection must be made at the drafthood outlet. A water heater cannot operate properly without the original venting system. An undersized system will cause formation of condensate, leakage, spillage, water heater malfunction, etc.

VERTICAL EXHAUST GAS VENT

Vertical exhaust gas vents must be installed with UL listed type B vent pipe according to the vent manufacturer's instructions and the terms of its listing.

It must be connected to the water heater's drafthood by a certified vent connector or by directly originating at the drafthood opening.

Vertical gas vents must be terminated with a listed cap or other roof assembly and be installed according to their manufacturer's instructions.

WATER PIPING

Pipes and fittings should be installed in compliance with the installation drawing. Check for dip tube in cold water fitting before connection of HOT and cold water lines. If the indoor installation area is subject to freezing temperatures, water piping must be protected. The water heater should be drained if being shut down during freezing temperatures.

If solder connections are used, sweat tubing to the adaptor before fitting adaptor to the cold and hot water fitting. It is imperative that no heat be applied to the water heater fitting as they may contain non-metallic parts.

⚠ CAUTION: OPERATING AN EMPTY OR PARTIALLY FILLED WATER HEATER WILL RESULT IN DAMAGE TO THE TANK

Install the water piping and fitting as shown in Figure 4.

1. Connect the cold water supply (3/4" NPT) to the fitting marked "C". Connect the hot water supply (3/3" NPT) to the fitting marked "H". Important: some models may contain energy saving heat traps to prevent the circulation of hot water within the pipes. Do not remove the inserts within the heat traps.
2. The installation of unions in both the hot and cold water supply lines is recommended for ease of removing the water heater for service or replacement.
3. The manufacturer of this water heater recommends installing a tempering valve or an anti-scald device in the domestic hot water line. These valves reduce the point-of-use temperature of the water by mixing cold and hot water and are readily available for use.
4. Install a shut-off valve in the cold water inlet line. It should be located close to the water heater and be easily accessible. Know the location of this valve and how to shut off the water to the heater.
5. A temperature and pressure relief valve must be installed in the opening marked "Temperature and Pressure (T&P) Relief Valve" on the water heater.
6. Add a discharge line to the opening of the T&P relief valve. Follow the instructions under "Temperature and Pressure Relief Valve".
7. After piping has been properly connected to the water heater, remove the aerator at the nearest hot water faucet. Open the hot water faucet and allow the tank to completely fill with water. To purge the lines of any excess air, keep the hot water faucet open for 3 minutes after a constant flow of water is obtained. Close the faucet. Check all connections for leaks. Replace the aerator.

PRESSURE BUILD-UP IN CLOSED WATER SYSTEMS

The water utility supply meter may contain a check valve, back-flow preventer, or water pressure reducing valve. This will create a closed water system. During the heating cycle of the water heater, water expands creating a pressure build-up in the water system. A temperature and pressure relief valve must be installed on the water heater (ISO PSI maximum pressure setting. See Temperature and Pressure Relief Valve Page 9).

To prevent the temperature and pressure relief valve from discharging hot water, loss of energy, and reduce the possible build up of lime on the water temperature and pressure relief valve seat. An expansion tank must be installed on the cold water supply line. For every 50 US gallons of stored water, the expansion tank must have a minimum capacity of 1.5 US gallons, see Figure 4.

TEMPERATURE & PRESSURE RELIEF VALVE

For protection against excessive pressures and/or temperatures, a temperature and pressure relief valve must be installed in the opening marked, "temperature and pressure Relief Valve". A design certified by a nationally recognized testing laboratory that maintains periodic inspection of production of listed equipment or materials, as meeting the requirements for Relief Valves and Automatic Gas Shut-Off Devices for Hot Water Supply Systems, 221.22 is furnished with this water heater.

Do not thread, cap, or plug the end of this discharge line. Do not connect discharge line directly to drain (Figure 4).

To prevent bodily injury, hazard to life or damage to property, the relief valve must be allowed to discharge water in the event of excessive temperature or pressure developing in the water heater.

The function of the temperature and pressure Relief Valve is to discharge water in large quantities should circumstances demand. If the discharge pipe is not directed to the drain, as shown in Figure 4, or other suitable means, the water flow may cause property damage.

THE DISCHARGE LINE

- (1) Must not be smaller than the pipe size of the Relief Valve.
- (2) Must not be plugged or blocked.
- (3) Must be of material capable of withstanding 210 °F without distortion.
- (4) Must be installed so as to allow complete drainage of both the temperature and pressure Relief Valve and discharge line.
- (5) Must terminate at an adequate drain.
- (6) Must not have any valve between the Relief Valve and the heater.

Failure to maintain the properly listed temperature and pressure Relief Valve will release the manufacturer from any claims which might result from excessive temperature or water pressure.

Manually operate the temperature and pressure Relief Valve at least once a year (Figure 11). To prevent water damage, discharge line must terminate at an adequate drain (Figure 4).

Standing clear of the outlet (discharge water may be hot), lift and release the handle on the temperature and pressure Relief Valve to make the valve operates freely. If the heater is installed in a closed system, the temperature and pressure Relief Valve may drip at times. If the temperature and pressure Relief Valve discharges a full stream of water, have the system checked. See "Pressure Build-Up in Water System".

If the temperature and pressure relief valve on the appliance discharges periodically, this may be due to thermal expansion in a closed water supply system (see "Pressure Build-Up in Water System"). Contact the water supplier or local plumbing inspector on how to correct this situation. Do not plug the temperature and pressure Relief Valve.

T&P Relief Valve and Pipe Insulation (Only Models with insulation material included in the package).

1. Locate the T&P Relief Valve on the Water Heater.
2. Locate the slit running the length of the insulation.
3. Spread this slit open and slip it over the T&P Relief Valve (See Figure 11). Apply gentle pressure to the insulation to ensure it is fully seated on the T&P Relief Valve. Once sealed, secure the insulation with a section of tape. **IMPORTANT:** The insulation or tape should not block or cover the T&P Relief Valve drain opening. Also the insulation or tape should not block or cover the T&P Relief Valve drain opening. Also the insulation or tape should not block or hinder access to the T&P Relief Valve manual relief lever.
4. Next locate the hot water (outlet) & cold water (inlet) pipes to the water heater.
5. Select one of the sections of pipe insulation and locate the slit that runs the length of the insulation.
6. Spread the slit open at the base of the insulation and slip it over the cold water (inlet) pipe. Apply gentle pressure along the length of the insulation to ensure it is fully seated around the cold water pipe. Also ensure that the base of insulation is flush with the water heater. Once seated, secure the insulation with a section of tape.
7. Repeat steps 5 through 6 for the hot water (outlet) pipe.

⚠ WARNING: Installations above the rated altitude as specified on the rating label are not authorized and may result in improper and inefficient operation of the appliance, producing carbon monoxide gas in excess of acceptable limits, which could result in serious injury or death.

High Altitude

Input rating of this water heater is based on sea level operation. At higher elevations, the actual input rate may be lower than the value listed on the rating label due to the derating of natural gas and LP gas. This water heater can be installed at elevation up to the elevation listed on the rating plate attached to the water heater without any change or modification.

T&P Relief Valve Insulation

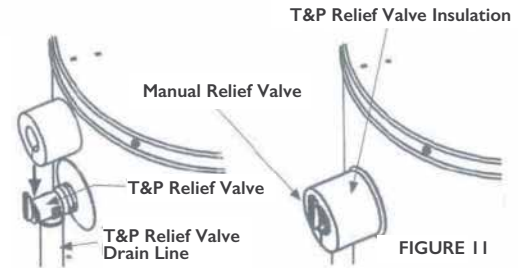

DO NOT use this water heater as a replacement for an existing boiler installation.

DO NOT use with piping that has been treated with chromates, boiler seal or other chemicals.

DO NOT add boiler treatment or any chemicals to any heat piping, since the piping contains potable water.

DO NOT use with ferrous piping. The system should be installed only with new piping that is suitable for potable water such as copper or polybutylene.

DO NOT use with PVC piping.

DO NOT use any pumps, valves, or fittings that are not completely compatible with potable water piping.

DO NOT use valves that may cause excessive restriction to water flow.

USE FULL FLOW BALL OR GATES VALVES ONLY.

DO NOT tamper with the thermostat, gas valve, igniter control or temperature and pressure relief valve. Tampering with any of these components is DANGEROUS and can result in property damage or severe injury. Tampering voids all warranties. Only qualified personnel should service these components.

DO NOT use 50/50 solder in potable water lines.

SOLAR INSTALLATION

When this appliance is used AS A SOLAR STORAGE HEATER OR AS A BACK UP FOR THE SOLAR SYSTEM, the following warning applies.

WARNING

Water supply to this heater must not exceed 180 °F. Water temperature in excess of 180 °F will cause the high limit control to function or open and shut off gas supply. The high limit control is a single use type that will require the replacement of the thermostat before the burner can operate. If the water supply from the solar system is above 120 °F a tempering valve or temperature limiting valves must be installed in the water supply line to limit the supply temperature to 120 °F.

CAUTION

INSULATION BLANKET

Insulation blanket kits which are available for external applications to water heaters are not recommended. However, some governing bodies require their use in new construction of additions, regardless of how efficient the water heater may be.

If an insulation blanket is applied to this heater CAUTION must be exercised not to restrict the proper function of the heater. The manufacturer of this heater will not be liable for incidents arising or resulting, from the use of external insulation blankets. The manufacturer will not be liable for corrosion of parts which may have resulted from the use of such insulation blankets.

The space between the base and the floor on a gas water heater is necessary for proper air flow. This space must be maintained unobstructed. As time passes, the blanket may sag causing an obstruction of this air passage, resulting in an unsafe operating condition.

Do not apply insulation to the top of a gas water heater. This will affect the operation of the draft hood, resulting in an unsafe operating condition.

Do not cover any access panels leading to burner compartments, thermostat(s) control, doors, or temperature & pressure relief valve on the water heater.

Do not cover any labels or instruction material applied to this water heater, these safety labels and instruction materials must remain on the water heater and be visible for reference by the user. Do not attempt to remove these labels, as they are a permanent part of this water heater as required by Certification Agencies and/or the Federal Government.

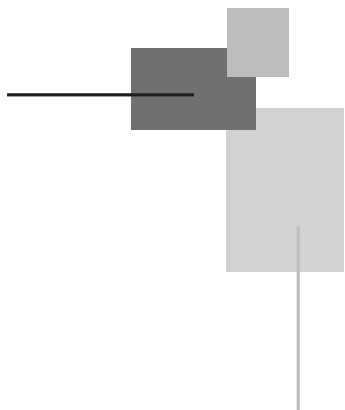

FOR YOUR SAFETY READ BEFORE LIGHTING



WARNING: If you do not follow these instructions exactly, a fire or explosion may result causing property damage, personal injury or loss of life.



BEFORE OPERATING: ENTIRE SYSTEM MUST BE FILLED WITH WATER AND AIR PURGED FROM ALL LINES.

- A. This appliance has a pilot which is lit by a piezo-electric spark gas ignition system. Do not open the inner compartment of the appliance and try to light the pilot by hand.
- B. **BEFORE LIGHTING** smell all around the appliance area for gas. Be sure to smell next to the floor because some gas is heavier than air and will settle on the floor.
- WHAT TO DO IF YOU SMELL GAS:**
- Do not light any appliance.
 - Do not touch any electric switch; do not use any telephone in your building.
 - Immediately call your gas supplier from a neighbor's telephone. Follow the gas suppliers' instructions.
- If you cannot reach your gas supplier, call the fire department.
- C. Use only your hand to push in or turn the gas control knob. Never use tools. If the knob will not push in or turn by hand, don't try to repair it, call a qualified service technician. Force or attempted repair may result in a fire or explosion.
- D. Do not use this appliance if any part has been under water or if there has been an ignition of vapors immediately call a qualified service technician to inspect or replace the water heater. Water heaters subjected to a flammable vapors ignition will show a discoloration on the air intake grid and require replacement of the entire water heater.

LIGHTING INSTRUCTIONS

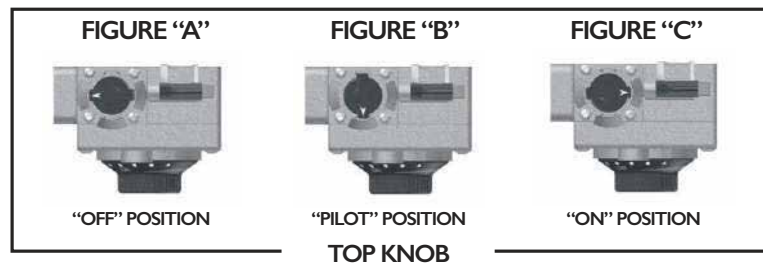
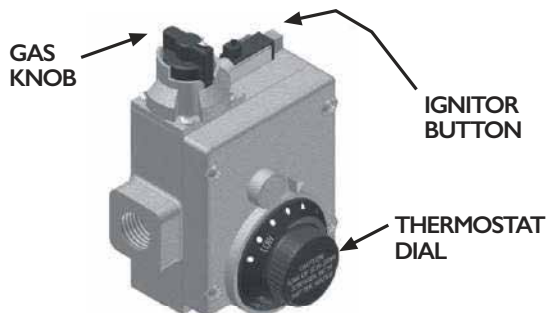

1. **STOP!** Read the safety information above on this label.
2. Set the thermostat to lowest setting (PILOT LIGHTING). Turn the thermostat dial fully clockwise until it stops.
3. Push the gas control knob down slightly and turn clockwise to "OFF", see Figure "A".
NOTE: Knob CANNOT be turned from "PILOT" to "OFF" unless it is pushed down slightly. Do not force.
4. Remove the outer burner door located below the gas control.
5. Wait five (5) minutes to clear out any gas. If you then smell gas, **STOP!** Follow "B" in the safety information above on this label. If you don't smell gas, go to next step.
6. This unit is equipped with a push button pilot ignitor, which is used to light the pilot. Locate the ignitor on the gas control.
7. Turn gas control knob counterclockwise to "PILOT", see Figure "B".
8. The pilot can be located by looking through the glass view port while pressing the piezo ignitor button. Look for a spark at the pilot location.
9. Once the pilot has been found, push the gas knob all the way down. Immediately press the pilot ignitor button rapidly (4) to (5) times. If the pilot will not light, repeat steps (3) through (9).
10. Continue to hold the gas control knob down for about one (1) minute after the pilot is lit. Release the gas control knob and it will pop back up. Pilot should remain lit. If it goes out, repeat steps (3) through (9). It may take several minutes for air to clear the lines before the pilot will light.
 - If knob does not pop up when released, stop and immediately call your service technician or gas supplier
 - If the pilot will not stay lit after several tries, turn the gas control knob clockwise to "OFF" and call your service technician or gas supplier; see Figure "A".
11. Once the pilot flame is established replace the outer burner door.
12. At an arm's length away, turn gas control knob counterclockwise to "ON", see Figure "C".
13. To insure that the Burner is ignited look for an orange glow from the burner thru the pilot viewing window.
14. Set thermostat to desired setting.

DANGER: Hotter water increases the risk of scald injury. Consult the instruction manual before changing temperature.

TO TURN OFF GAS TO APPLIANCE

1. Set thermostat Dial to the lowest setting (PILOT LIGHTING).
2. Push gas control knob down slightly and turn clockwise to "OFF", see Figure "A". Do not force

GAS REQUIREMENTS

Read the data plate to be sure the water heater is made for the type of gas you will be using in your home. This information will be found on the data plate located near the gas control valve. If the information does not match with the type of gas available, do not install or light. Call your dealer.

Note: An odorant is added by the gas supplier to the gas used by this water heater. This odorant may fade over an extended period of time. Do not depend upon this odorant as an indication of leaking gas.

GAS PIPING INSTALLATION

All piping must comply with local and state ordinances or with the National Fuel Gas Code ANSI Z223.1 (NFPA 54), whichever applies.

Use black iron pipe or equivalent material approved by local codes and ordinances for gas piping. Install a ground-joint-union in the supply line as close to the water heater as possible. A manual gas shut-off valve should be at least 5 feet above floor level and readily accessible. A drip leg (consisting of a pipe tee, 4 inch nipple, and cap) should be installed as shown in Figure 13.

⚠ WARNING



Explosion Hazard
Install a shut off valve.
Do not connect a natural gas water heater to a L.P gas supply.
Do not connect a L.P. gas water heater to a natural gas supply.
Failure to follow these instructions can result in death, explosion, or carbon monoxide poisoning.

Make sure the gas supplied to the heater is the same type as listed on the rating plate. **DO NOT ATTEMPT TO USE THIS WATER HEATER WITH ANY GAS OTHER THAN THE TYPE LISTED ON THE RATING PLATE.**

Compound set for the connection of all gas piping should be resistant to the action of liquefied petroleum (L.P.) gases. Apply pipe dope sparingly to the male threads only. **DO NOT** apply pipe dope to the gas valve.

The water heater and its individual gas shut off valve must be disconnected from the gas supply piping system during any pressure testing of the system at test pressure in excess of 1/2 psi. (14".W.C.) or 3.5 kPa.

If the gas valve is subjected to pressure exceeding 1/2 psi. the damage to the gas valve could result in an extremely hazardous condition. If this has occurred, the gas valve must be replaced. Contact your dealer for service.

It is recommended that all service work be done by a qualified service agency.

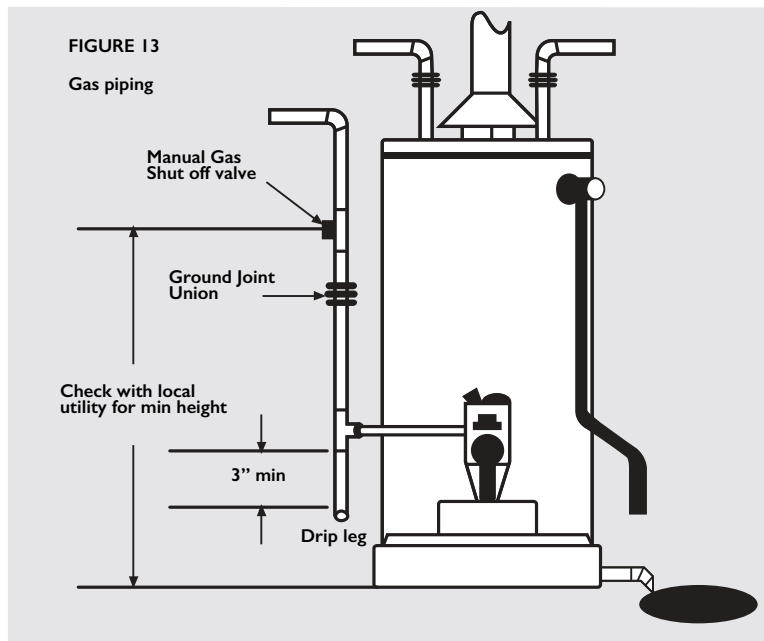

NOTE:
Control valves for L.P. gas have left hand threads.

LP GAS

⚠ WARNING



Explosion Hazard
Have a qualified service technician make sure L.P. gas pressure does not exceed 13" water column.
Failure to do so can result in death, explosion, or fire.

⚠ INSTALLATION SAFETY WARNING

L.P. UNITS: Liquefied petroleum (L.P.) gas is heavier than air and will remain at floor level if there is a leak. Basements, crawl spaces, closet and areas below ground level will serve as pockets for accumulation of leaking gas. Before lighting, sniff at floor level. **IF YOU SMELL GAS**, follow applicable instructions on the front cover.

GAS PRESSURE

Important: The gas supply pressure must not exceed the maximum supply pressure as stated on the water heater's data plate. The minimum supply pressure is for the purpose of input adjustment.

Note: Air may be present in the gas lines and could prevent the pilot from lighting on initial start-up. The gas lines should be purged of air by a qualified service technician after installation of the gas piping system.



WARNING: DO NOT OPERATE APPLIANCE UNTIL ALL LEAKS ARE CORRECTED. DO NOT USE OPEN FLAME OR ANY KIND OF SPARK TO CHECK FOR LEAKS.

PIEZOELECTRIC IGNITER SYSTEM

The piezo electric igniter system is part of the VAPOR SHIELD Safety System and consists of the igniter button, electrode and wire. The pilot is ignited by an electric spark generated when the igniter button is pressed. The spark gap of 0.125 inch is set when the electrode is installed at the factory (see Figure 14). Use only factory authorized VAPOR SHIELD Safety System for replacement.

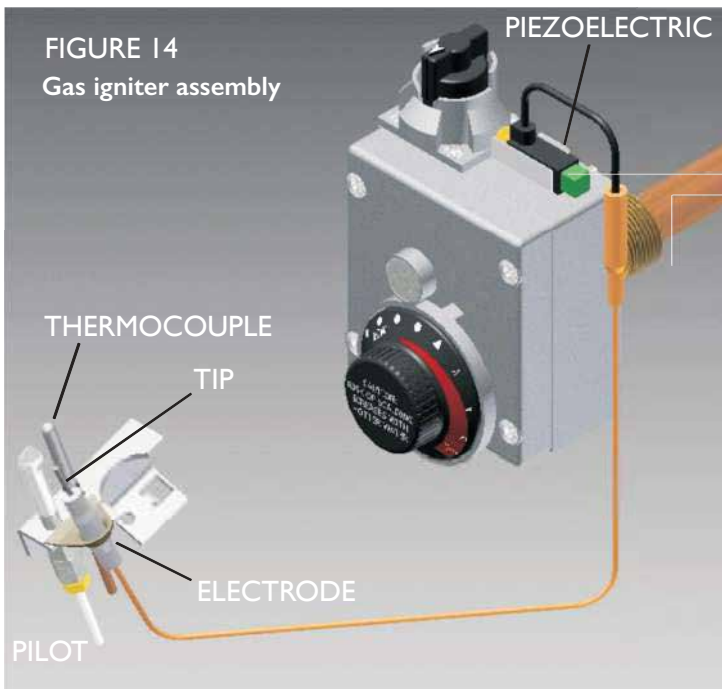

TESTING THE IGNITER SYSTEM

Turn off the gas to the water heater at the manual gas shut off valve. Through the burner view port watch the electrode tip while activating the igniter. A visible spark should jump from the electrode. To avoid shock, do not touch the igniter or igniter wire. If no spark is visible, check the wire connections. Replace the igniter if defective.

REMOVING AND REPLACING THE GAS CONTROL VALVE/THERMOSTAT

Important: The gas control valve/thermostat is a standard valve.

1. On the gas control valve/thermostat turn the temperature dial clockwise to its lowest setting. Turn the gas control knob clockwise to the "OFF" position (Page 10 "Gas Control").
2. Turn off the gas at the manual shut-off valve on the gas supply pipe (Figure 13 - Page 11 or Figure 4 - Page 4).
3. Drain the water heater. Refer to the section of "Draining and Flushing" on page 14 and follow the procedure.
4. Disconnect the igniter wire from the igniter button. Remove the igniter button. Remove igniter bracket. Disconnect the thermocouple, the high temperature cut off switch, pilot and tube and manifold tube at the thermostat.
Note: L.P. gas system use reverse (left-hand) threads on the manifold tube.
5. Refer to "Gas Piping" (Figure 4 - Page 4) and disconnect the ground joint union in the gas piping. Disconnect the remaining pipe from the gas valve/thermostat.
6. **Important** when removing the gas control valve/thermostat do not use pipe wrench or vise the grip body. Do not insert any type of blunt instrument into the inlet or outlet connections. Using these type of tools may result in damage to the gas control valve/thermostat.
7. Turn the gas control valve/thermostat counter-clockwise. Remove the gas control valve/thermostat.

To replace the gas control valve/thermostat, reassemble in reverse order:

- Be sure to use approved Teflon tape or pipe joint compound on the gas piping connections and fitting on the back of the gas valve that screws into tank.
- Be sure to remove the pilot ferrule nut from the new gas control valve/thermostat.
- Turn gas supply on and check for leaks. Use a chloride-free soap and water solution (bubbles forming indicate a leak) or other approved method.
- Be sure tank is completely filled with water before lighting and activating the water heater. Follow the "Lighting Instructions" on page 10.
- If additional information is required, contact the Service Department on the phone number shown on the facing page of this manual.

REPLACING THE HIGH TEMPERATURE CUT OFF SWITCH ASSEMBLY

Your American Standard VAPOR SHIELD water heater is equipped with a high temperature cut off switch that is provided to shut down the water heater when the incoming air is insufficient for proper combustion. If the screen air intake becomes blocked, the high temperature cut off switch will shut down the pilot and cut off the flow of current from the thermocouple to the control valve shutting off the flow of gas to the burner. This is highly unlikely since this high temperature cut off switch is required to function only when the air intake screen becomes blocked. If such an incident occurs however the small screen to the left of the burner should be checked for blockage and the high temperature cut off switch should be checked to determine if it has shut off. If switch has shut off, merely clean the screen per the previous instructions and press the red reset button on the end of the switch. You should then be able to restart the heater according to the start up instructions. If the water heater will not start in this manner, proceed according to the following:

Instructions.

- 1.- Disconnect the manifold, pilot tube, thermocouple and piezo ignition off switch wires from the wire terminals on the switch. These are slip on two wire spade connection. Pull the piezo igniter off the control. It is held in place with a spring clip.
- 2.- Remove the 6 bolts holding the burner mounting plate in the combustion chamber.
- 3.- Slide the burner carefully out of the combustion chamber excising care not to damage the burner mounting gasket.
- 4.- Once the burner is removed, drill out the four screws holding the high temperature cut off switch assembly bracket on to the burner with a socket type 5/16" screwdriver. Replace the defective high temperature cut off switch assembly bracket with a factory supplied switch assembly bracket that includes sheet metal screws and appropriate washers.
Note: Only factory provided switches, washers and screws can be used for this replacement.
- 5.- Re-install the burner taking care not to damage the burner plate mounting gasket or the pilot assembly.
- 6.- Re-connect the manifold, pilot tubing and thermocouple, using a small wrap of Teflon tape on the manifold nut. Do not ever tighten the thermocouple nut. Finger tight plus 1/4 turn with a wrench is sufficient. Reconnect the high temperature cut off switch assembly, slip on the two spade connections wires and be sure to reset this heat switch pushing softly the red button.
- 7.- Turn on the gas and make sure all connections are tight and you cannot smell gas. Then light the heater according to the lighting instructions. When the burner comes on, check for leaks at the manifold nut and pilot connection with a soapy water solution.

THERMOCOUPLE, PILOT AND PIEZO IGNITER REPLACEMENT

In the unlikely event that it would be necessary to replace the piezo igniter, pilot or thermocouple it is necessary to replace the entire pilot assembly. These parts are all part of this assembly and cannot be replaced separately. To replace this assembly follow the instructions for removing the burner that are provided for the thermocouple replacements. After removing the burner assembly, unscrew the pilot bracket from the burner and remove the rubber grommet from the burner mounting plate. Attach the entire pilot assembly which includes the thermocouple, pilot, piezo igniter and rubber grommet to the burner. Run the pilot tube, thermocouple and piezo igniter wire, through the hole in the burner mounting plate then push the new rubber grommet into the hole in the burner mounting plate.

Reinstall the ends of the various fittings and be sure to test for leaks in the manner shown for thermocouple replacements.

REMOVAL OF THE BURNER ASSEMBLY

BURNER ADJUSTMENT

There are no adjustments to this water heater (other than water temperature selection). The thermostat (gas control valve) is equipped for total regulation of the main burner and pilot gas pressures. Only qualified personnel should adjust the pressure regulator.

BURNER MAINTENANCE

At least once a year a visual inspection should be made of the main burner and pilot burner. You should check for sooting, soot is not normal and will impair proper combustion.

In the event that cleaning becomes necessary, it can be accomplished by removing the burner from the combustion chamber. To remove the burner, disconnect the gas manifold, the pilot tube, and the thermocouple from the gas control.

Then disconnect the piezo ignition wire at the spade connection where it is attached to the piezo igniter bottom assembly on the control and unplug the high temperature cut off switch. After this is done the complete burner assembly can be removed from the combustion chamber by removing the six mounting screws. Care must be exercised in doing this to ensure that the gaskets and the pilot assembly are not torn or damaged. If they are damaged they must be replaced. Once the burner assembly is removed it can be cleaned with a vacuum cleaner by vacuuming both the top and bottom surfaces.

When reinstalling the burner assembly, make sure all gasket material is positioned properly. If any of the gaskets are damaged the heater cannot be put back in operation until the damaged gaskets are replaced.

-Your water heater will perform better and be trouble free longer in a clear environment. Keep the area around the water heater free of dirt and dust. If excessive dust and dirt are allowed to be drawn into the burner, the heater may start recycling more often than necessary. If this should ever occur, only an experienced technician should open the front door panel to clean the combustion chamber.

WARNING: DO NOT ATTEMPT TO REMOVE THE BURNER FROM THE COMBUSTION CHAMBER UNLESS YOU ARE QUALIFIED TO DO SO.



WARNING: IF YOU LACK THE NECESSARY SKILLS TO REMOVE AND REPLACE THIS BURNER, DO NOT ATTEMPT TO DO SO. CALL A QUALIFIED TECHNICIAN.

DRAINING AND FLUSHING INTERIOR OF TANK

The water heater should be drained if being shut down during freezing temperatures. Also periodic draining and cleaning of sediment from tank may be necessary.

1. "TURN OFF GAS TO APPLIANCE" (Figure 4).
2. Close the cold water inlet valve to the heater (Figure 4).
3. Open a nearby hot water faucet.
4. Open the heater drain valve (Figure 4).

WARNING:

THIS WATER CAN BE HOT

5. If the heater is going to be shut down and drained to an extended period, the drain valve should be left open. Refer to "Hydrogen Gas" warning (Page 17)
6. To start heater again, read paragraph "Operation" and "LIGHTING INSTRUCTIONS" (PAGE 10)

VENTING SYSTEM INSPECTION

Check the draft hood relief opening (Figure 4) using a match flame after 15 minutes of operation. Pass the match flame around the relief opening of the draft hood. A steady flame drawn into the opening indicates proper draft. If the flame flutters or is blown out this would indicate spillage and corrective action must be made to the vent. (Figure 4).

At least every 3 months a visual inspection should be made of the venting system. You should look for:

- Obstructions which cause improper venting.
- Damage or deterioration which could cause improper venting or leakage of combustion products.

 **NOTE:** This water heater when set at the lower temperature setting is not capable of producing hot water of sufficient temperatures for sanitizing purposes. During winter season or any cold period, you may desire a higher temperature setting to adjust for the colder incoming water. However, this adjustment may cause additional condensation to form on the cooler tank surface. This does not mean the tank is leaking. Refer to Page 17 for explanation of this condition. During the summer months, the warmer incoming water temperatures will benefit the performance of your water heater and reduce the amount of condensation developed.

Condensation does not mean that your tank is leaking. Over 40% of reported tank leaks on installation are proven to be condensation. To avoid unnecessary inconvenience and expense, make sure the tank is leaking before calling a service person.

 **CAUTION:** Setting the temperature selector dial higher provides hotter water, which increases the risk of scald injury.

The water heater thermostat is constructed with a built-in shut-off designed to shut off the gas supply to the main Burner and pilot Burner in the event the pilot flame is extinguished for any reason. The thermostat is also equipped with a high temperature limit switch ECO (Energy Cut Off) The Energy Cut Off will shut off all gas supplied to the Burner and pilot Burner in the event the water temperature exceeds 180 °F. The Energy Cut Off Switch is a single use switch and is not field replaceable. Should the Energy Cut Off function (open), the thermostat must be replaced before the water heater can be placed in operation again.

WARNING:

TAMPERING

Tampering with the thermostat, gas valve, pilot, burner, or temperature and pressure relief valve is **DANGEROUS** and voids all warranties. Only qualified personnel should service these components.

TEMPERATURE ADJUSTMENT

The temperature selector dial has been adjusted to its lowest setting when shipped from the factory.

For energy-efficient operation of your water heater, the recommended temperature setting is approximately 130 °F. Households with small children may require a 120 °F or lower temperature setting to reduce the risk of scald injury. Some states require a lower temperature setting. Check with your gas supplier for local requirements governing the temperature setting.

 **NOTE:** The lower the temperature setting, greater the energy efficiency, both to heat water and to maintain its temperature during standby periods. Lower water temperatures also extend the tank life.

Remember, no water heating system will provide exact temperatures at all times. Allow a few days of operation at this setting to determine the correct temperature setting consistent with your needs.

VACATION / FREEZING TEMPERATURES - If the water heater is to remain idle for 30 days or more, or is subject to freezing temperatures while shut off, the water heater and piping should be drained, and the drain valve should be left open.

GAS PRESSURE - With the water heater in operation (main burner on), the maximum supply pressure must not exceed the specified value below, and the minimum supply and normal manifold gas pressure are as follows:

	Supply Pressure		Manifold Pressure
	MAX	MIN	NORMAL
Natural Gas	11" W.C.	6" W.C.	15" W.C.
L.P. Gas	13.0" W.C.	11" W.C.	10" W.C.

Some models have values higher or lower than those noted above. Refer to pressure noted on the label affixed to the front of the water heater. Consult your local gas company or gas supplier if correction is necessary.

EMERGENCY SHUT DOWN

Should overheating occur or the gas supply fail to shut off, turn off the manual gas control valve to the appliance and call a qualified service person to check for the cause.

WARNING: Stacking

Stacking occurs when a series of short draws of hot water (3 gallons or less) are taken from the water heater tank. This causes increased cycling of the burner and can result in increased water temperatures at the hot water outlet. An anti scald device is recommended in the hot water supply line to avoid this problem.

OPERATION SAFETY PRECAUTIONS:

DO turn off heater if it has been subjected to physical damage, flooding or fire.

DO NOT turn on heater unless it is completely filled with water.

DO NOT turn on heater if cold water supply inlet valve is closed.

DO NOT attempt to light heater until all lighting instructions are understood and followed. See label on heater near thermostat.

DO NOT allow flammable liquids, such as gasoline or paint thinner, to be stored or used near heater. **DO NOT** allow combustible materials such as newspaper, rags or mops to accumulate near heater.

CONDENSATION

Whenever the heater is filled with cold water or hot water is drawn from a faucet there will be a certain amount of condensation formed while the burner is "ON". Moisture from the products of combustion condenses on the cooler tank surfaces and forms drops of water which may fall onto the burner or other hot surfaces to produce a "sizzling" or "frying" noise. Condensation is normal and should not be confused with a leaking tank.

The water from condensation will be noted at different times of the year in varying quantities. This condensations may spill out of the bottom pan on the floor. Do not confuse this with a leak. Once the water inside of the heater reaches a temperature of 120 °F, the condensations will stop.

Operating the water heater at the lowest thermostat temperature setting can keep the water heater in the condensation mode. Adjusting the thermostat setting slightly higher will overcome this problem. There is hot water scald potential however if the thermostat is set too high.

SMOKE/ODOR

The water heater may give off a small amount of smoke and odor during the initial start-up of the unit. This is due to the burning off of oil from metal parts of a new unit and will disappear after a few minutes of operation.

NATURAL GAS MODELS IF YOU SMELL GAS:

1. Open windows.
2. Get all people out of building.
3. **DO NOT** light matches. Do not smoke.
4. **DO NOT** touch electrical switches (on or off).
5. Extinguish any open flames.
6. Shut off gas at manual shut-off valve.
7. Use an outside telephone to call the gas company and the fire department. Ask for instructions. Before hanging up, give your name and address.
8. **DO NOT** go back into the building. If help is coming, wait for it outside of the building.

L.P.G (PROPANE, BOTTLED) GAS MODELS L.P.G IS HEAVIER THAN AIR

Should there be a leak in the system, the gas will settle at FLOOR LEVEL. Basements, crawl spaces, skirted areas under mobile homes (even when ventilated), closets and areas below ground level will serve as pockets for the accumulation of gas.

BEFORE LIGHTING SNIFF AT FLOOR LEVEL. IF YOU SMELL GAS, FOLLOW THESE RULES:

1. Open windows.
2. Get all people out of building.
3. **DO NOT** light matches. Do not smoke.
4. **DO NOT** touch electrical switches (on or off).
5. Extinguish any open flames.
6. Shut off gas at L.P. tank outside of the building.
7. Use an outside telephone and immediately call the L.P. Gas supplier and the fire department. Ask for instructions. Before hanging up, give your name and address.
8. **DO NOT** go back into the building. If help is coming, wait for it outside of the building.

OUT OF FUEL

When your L.P. tank runs out of fuel, turn off gas at all gas appliances-including gas to the pilots. After L.P. tank is refilled, all appliances must be re-lit according to the manufacturer's instructions.

WARNING

HYDROGEN GAS

Hydrogen gas can be produced in a water system that has not been used for a long period of time (generally two weeks or more). **HYDROGEN GAS IS EXTREMELY FLAMMABLE.** To prevent the possibility of injury under these conditions, we recommend the hot water faucet be open for several minutes at the kitchen sink before you use any electrical appliance which is connected to the hot water system.

Do not light a cigarette, cigar or pipe. Do not smoke. If hydrogen is present, there will probably be an unusual sound such as air escaping through the faucet, as the water begins to flow. Remember no smoking or open flame near the faucet at the time it is opened.

EXPOSURE TO WATER

Do not use this appliance if any part has been under water. Immediately call a qualified service technician to inspect the appliance and to replace any part of the control system and any gas control which has been under water.

ANODE

In each water heater there is installed at least one anode rod (see Parts section) for protection of the tank. Certain water conditions will cause a reaction between this rod and the water. This is defined as smelly water and removal of the rod will void any warranties stated or implied. However, this rod is only good to a certain point, after which we can only suggest that a water conditioning company be contacted to supply filtration equipment.

The anode rod is a sacrificial metal rod that avoids corrosion and premature failure (leaks) in the tank. It is a consumable item. Inspect the anode rod after the first six months of operation when you drain and flush the tank. Replace the anode rod if it's substantially worn out or has depleted. Thereafter, inspect the anode rod annually or more frequently if needed. If you use a water softener, your anode rod will deplete faster than normal and as such would need more frequent inspection.

Once the anode rod has been depleted, it will need to be replaced. Please consult the "Parts" section to see the Spare Parts code and contact your plumbing supplier to obtain it. (Anode rods are a consumable item and are not covered under warranty). Certain water conditions will cause a reaction between this rod and the water heater, potentially causing smelly water.

The parts list includes a special anode for such cases in which the water has a different odor or discoloration due to this reaction. A water conditioning company might have to be contacted to supply filtration equipment if the issue persists.

Failure to inspect the anode rod at least once a year could cause the tank to fail and leak. This condition is not covered under the manufacturer warranty.



WATER HEATER SOUNDS

1. Possible noises due to expansion and contraction of some metal parts during periods of heat up and cool-down do not represent harmful or dangerous conditions.

2. Sediment build-up in the tank bottom will create varying amounts of noise, and may cause premature tank failure. Tank bottom may need cleaning (See "DRAINING AND FLUSHING INTERIOR OF TANK" Page 14.).

Condensation causes sizzling and popping within the burner area during heating and cooling periods and should be considered normal. See "CONDENSATION" Page 16.

TAMPERINGS

Tampering with the thermostat, gas valve, pilot, burner, or temperature and pressure relief valve is **DANGEROUS** and voids all warranties. Only qualified personnel should service these components.

SERVICE MUST BE PERFORMED BY QUALIFIED INSTALLER, SERVICE AGENCY OR GAS SUPPLIER

THE FOLLOWING IS A LIST OF THE MOST COMMON COMPLAINTS RELATED TO THE USE OF WATER HEATERS. MANY COMPLAINTS ARE DUE TO ITEMS NOT DIRECTLY RELATED TO THE WATER HEATER. DO NOT ATTEMPT TO SERVICE THE WATER HEATER OR PERFORM OTHER RECOMMENDATIONS ON THIS LIST UNLESS YOU ARE TRAINED AND QUALIFIED TO DO SO.

VAPOR SHIELD System Operational Checklist

1. Manifold gasket properly sealed.
2. Viewport not damaged or cracked.
3. Pilot air duct screen not blocked.
4. No leaks at pilot and manifold connection.
5. Manifold door screws securely tightened.

TROUBLESHOOTING CHART

PROBLEM	POSSIBLE CAUSE(S)	CORRECTIVE ACTION
BURNER WILL NOT IGNITE	<ol style="list-style-type: none"> 1. Pilot not lit 2. Thermostat set too low 3. No gas 4. Dirt in the gas lines 5. Pilot line clogged 6. Main burner line clogged 7. Defective thermocouple 8. Defective thermostat 9. Heater installed in a confined area 	<ol style="list-style-type: none"> 1. Light pilot 2. Turn temperature, dial to desired temperature 3. Check with gas utility company 4. Notify utility-install trap in gas line 5. Clean, locate source and correct 6. Clean, locate source and correct 7. Replace thermocouple 8. Replace thermostat 9. Provide fresh air ventilation
SMELLY WATER	<ol style="list-style-type: none"> 1. Sulfides in the water 	<ol style="list-style-type: none"> 1. Replace the anode with a special anode
BURNER WILL NOT STAY LIT	<ol style="list-style-type: none"> 1. Insufficient air 2. Thermocouple malfunction 3. Dirty or clogged air intake screen 4. Flame arrestor openings blocked 5. Defective gas control 6. High ambient room temperature 	<ol style="list-style-type: none"> 1. Provide ventilation to water heater 2. Replace pilot assembly 3. Clean air intake screen 4. Call service number on front of this manual 5. Replace gas control 6. Call service number on front of this manual
PILOT WILL NOT LIGHT OR REMAIN LIT	<ol style="list-style-type: none"> 1. Air in gas line 2. No gas 3. Dirt in gas line 4. Pilot line or orifice clogged 5. Thermocouple connection loose 6. Defective Thermocouple 7. Cold drafts 8. Thermostat ECO switch open 9. High temperature cut off switch open 10. Defective Igniter 11. Pilot air intake duct screen blocked 12. Low gas pressure 	<ol style="list-style-type: none"> 1. Bleed the air from the pilot tube 2. Check with gas utility company 3. Notify utility-install dirt trap in gas line 4. Clean, locate source and correct 5. Finger tighten; then 1/4 turn with wrench 6. Replace thermocouple 7. Locate source and correct 8. Replace thermostat 9. Call service number on front of this manual 10. Replace igniter pilot assembly 11. Clean pilot duct air intake screen 12. Check with gas utility company
HIGH OPERATION COSTS	<ol style="list-style-type: none"> 1. Thermostat set too high 2. Sediment or lime in tank 3. Water heater too small for job 4. Wrong piping connections 5. Leaking faucets 6. Gas leaks 7. Wasted hot water 8. Long runs of exposed piping 9. Hot water piping in exposed wall 	<ol style="list-style-type: none"> 1. Set temperature dial to lower setting 2. Drain/flush-provide water treatment if needed 3. Install adequate heater 4. Correct piping-dip tube must be in cold inlet 5. Repair faucets 6. Check with utility-repair at once 7. Advise customer 8. Insulate piping 9. Insulate piping
INSUFFICIENT HOT WATER	<ol style="list-style-type: none"> 1. Thermostat set too low 2. Sediment or lime in tank 3. Water heater too small 4. Wrong piping connections 5. Leaking faucets 6. Wasted hot water 7. Long runs of exposed piping 8. Hot water piping in out side wall 9. Low gas pressure 	<ol style="list-style-type: none"> 1. Turn temperature dial to desired setting 2. Drain/flush-provide water treatment if needed 3. Install adequate heater 4. Correct piping-dip tube must be in cold inlet 5. Repair faucets 6. Advise customer 7. Insulate piping 8. Insulate piping 9. Check with gas utility company

TROUBLESHOOTING CHART

PROBLEM	POSSIBLE CAUSE(S)	CORRECTIVE ACTION
SLOW HOT WATER RECOVERY	<ol style="list-style-type: none"> 1. Insufficient secondary air 2. Flue clogged 3. Low gas pressure 4. Improper calibration 5. Thermostat set too low 6. Water heater too small 7. Wrong piping connections 8. Wasted hot water 	<ol style="list-style-type: none"> 1. Provide ventilation to water heater. Check flue way, flue baffle and burner 2. Clean flue, locate source and correct 3. Check with gas utility company 4. Replace thermostat 5. Turn temperature dial to desired setting 6. Install adequate heater 7. Correct piping-dip tube must be in cold inlet 8. Advise customer
DRIP FROM RELIEF VALVE	<ol style="list-style-type: none"> 1. Excessive water pressure 2. Heater stacking 3. Closed water system 	<ol style="list-style-type: none"> 1. Use a pressure reducing valve and relief valve 2. Lower the thermostat setting 3. See "Closed System / Thermal Expansion"
THERMOSTAT FAILS TO SHUT OFF	<ol style="list-style-type: none"> 1. Defective thermostat 2. Improper calibration 	<ol style="list-style-type: none"> 1. Replace thermostat 2. Replace thermostat
COMBUSTION ODORS	<ol style="list-style-type: none"> 1. Insufficient secondary air 2. Flue clogged 3. Heater installed in a confined area 	<ol style="list-style-type: none"> 1. Provide ventilation to water heater. Check flue way, flue baffle and burner 2. Clean, locate source and correct 3. Provide fresh air ventilation
SMOKING AND CARBON FORMATION (SOOTING)	<ol style="list-style-type: none"> 1. Insufficient secondary air 2. Low gas pressure 3. Flue clogged 4. Defective thermostat 5. Heater installed in a confined area 6. Burner flame yellow-lazy 	<ol style="list-style-type: none"> 1. Provide ventilation to water heater. Check flue way, flue baffle and burner 2. Check with gas utility company 3. Clean, locate source and correct 4. Replace thermostat 5. Provide fresh air ventilation 6. Clean venturi burner
CONDENSATION FLAME BURNS AT ORIFICE	<ol style="list-style-type: none"> 1. Temperature setting too low 2. Defective thermostat 3. Low gas pressure 	<ol style="list-style-type: none"> 1. Increase the temperature setting 2. Replace thermostat 3. Check with gas utility company
PILOT FLAME TOO SMALL	<ol style="list-style-type: none"> 1. Pilot line or orifice clogged 2. Low gas pressure 	<ol style="list-style-type: none"> 1. Clean, locate source and correct 2. Check with gas utility company

REPAIR PARTS ILLUSTRATION

ITEM PARTS DESCRIPTION

1. DRAFTHOOD
2. BAFFLE
3. COLD WATER DIP TUBE
4. HEAT TRAP (SOME MODELS)
5. ANODE ROD (NOT SHOWN)
6. TEMPERATURE & PRESSURE RELIEF VALVE
7. DRAIN VALVE
8. THERMOSTAT (PROPANE GAS THERMOSTAT WILL BE MARKED FOR LP GAS ONLY)
9. MANIFOLD
10. ORIFICE
11. MAIN BURNER
12. THERMOCOUPLE
13. PILOT TUBE
14. PILOT ASSEMBLY
15. MANIFOLD COVER



- Temperature & Pressure Relief Valve is required but may not be factory installed.
- It is imperative the replacement main burner, main burner orifice, manifold, pilot burner, and the thermostat be ordered for the proper gas type. Natural gas thermostat will be marked with a 5" pressure setting. Propane gas thermostat will be marked "For L.P. Gas Only".

WHEN ORDERING REPAIR PARTS ALWAYS GIVE THE FOLLOWING INFORMATION: (1) MODEL AND SERIAL NUMBER, (2) TYPE OF GAS, (3) ITEM NUMBER, (4) PARTS DESCRIPTION

THE PARTS MAY BE ORDERED THROUGH YOUR PLUMBER, A LOCAL SUPPLY COMPANY, OR DIRECTLY FROM THE FACTORY. PARTS WILL BE SHIPPED AND BILLED AT PREVAILING PRICES AT THE TIME OF SHIPMENT. REFER TO YOUR WARRANTY FOR FACTORY ADDRESS.

American Standard[®] Water Heaters



IF YOU NEED SERVICE

1. Should you have any questions about your new water heater, or if it requires adjustment, repair, or routine maintenance, it is suggested that you first contact your installer, plumbing contractor or previously agreed upon service agency. In the event the firm has moved, or is unavailable, refer to the telephone directory, commercial listings or local utility for qualified service assistance.
2. Should your problem not be solved to your complete satisfaction, you should then contact the Manufacturer's Service Department at the following address:

American Standard Water Heaters
561 New York Drive
Pomona, CA 91768
USA
1-888-883-0788

When contacting the manufacturer, the following information will be requested:

- a. Model and serial number of the water heater as shown on the rating plate attached to the jacket of the heater.
- b. Address where the water heater is located and physical location.
- c. Name and address of installer and any service agency who performed service on the water heater.
- d. Date of original installation and dates any service work was performed.
- e. Details of the problems as you can best describe them.
- f. List of people, with dates, who have been contacted regarding your problem.



Cal·o·Rex

Un buen baño te cambia el día

Cliente: Calorex

Fecha: 12/ SEPTIEMBRE/2023

Proyecto / marca: AS_Residential-Gas-water-Heater-GSN

Dimensiones: 21.59 x 27.94cm

Escala: 100%

Resolución : 300 dpi

Suaje: **Doblez:**

Tintas: **Selección de color:** **Tintas directas:**

OBSERVACIONES: