

MODELS:

Commercial 75-76 AS, 100-83 AS
Residential G75 T2 AS, G100 T2 AS

American Standard[®]
Water Heaters

**operating, installation and
service manual**

Commercial & Residential Gas Water Heaters

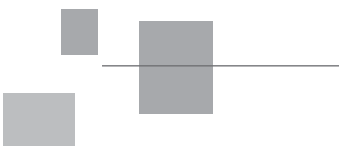

OPERATING, INSTALLATION AND SERVICE MANUAL

STORAGE TYPE GAS WATER HEATER



WARNING: If the information in these instructions is not followed exactly, a fire or explosion may result causing property damage, personal injury or death.

-Do not store or use gasoline or other flammable vapors and liquids in the vicinity of this or any other appliance.

-WHAT TO DO IF YOU SMELL GAS

- Do not try to light any appliance
- Do not touch any electrical switch; do not use any phone in your building.
- Immediately call your gas supplier from a neighbor's phone. Follow the gas supplier's instructions
- If you cannot reach your gas supplier, call the fire department.

- Installation and service must be performed by a qualified installer, service agency or the gas supplier.

THIS APPLIANCE SHALL NOT BE INSTALLED IN ANY LOCATION WHERE FLAMMABLE LIQUIDS OR VAPORS ARE LIKELY TO BE PRESENT. FLAMMABLE VAPORS MAY BE DRAWN TO THIS WATER HEATER FROM OTHER AREAS OF THE STRUCTURE BY AIR CURRENTS.



CAUTION: THIS WATER HEATER SHOULD NOT BE USED TO HEAT A SPA OR HOT TUB

THIS WATER HEATER SHALL NOT BE INSTALLED IN BATHROOMS, BEDROOMS, OR ANY OCCUPIED ROOM NORMALLY KEPT CLOSED.



WARNING



This water heater is equipped for one type gas only. Check the data plate near the control access panel for the correct gas. **DO NOT USE THIS WATER HEATER WITH ANY GAS OTHER THAN THE ONE LISTED ON THE DATA PLATE.** Failure to use the correct gas can cause problems which can result in **DEATH, SERIOUS BODILY INJURY OR PROPERTY DAMAGE.** If you have any questions or doubts consult your gas supplier or gas company. Water heaters for bottled, propane or liquefied petroleum gas (LPG) are different from natural gas models. A natural gas heater will not function safely on bottled, propane or liquefied petroleum gas (LPG) and no attempt should be made to convert a heater from natural gas to any other gas. An odorant is added to the gas used by this water heater.

IF YOU HAVE QUESTIONS THAT ARE NOT ANSWERED IN THE MANUAL YOU MAY CALL THE TOLL FREE NUMBER 800 900-9063 **DO NOT CONTACT US BY TELEPHONE OR EMAIL FOR WARRANTY REGISTRATION.** YOUR WATER HEATER SERIAL NUMBER IS ALREADY ON FILE. THE WARRANTY IS ACTIVATED AT THE TIME OF PURCHASE. KEEP YOUR RECEIPT TO SHOW TO SERVICE PERSON IF SERVICE IS REQUIRED.



DANGER

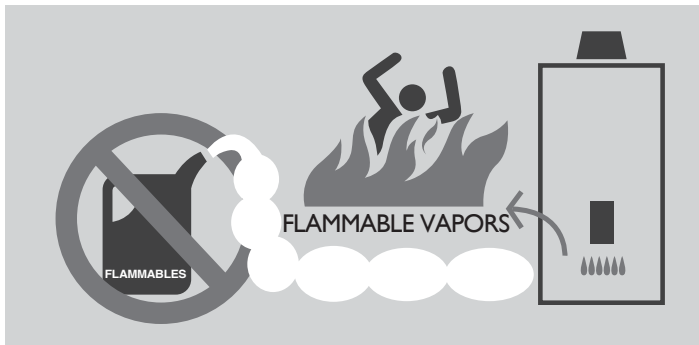

Vapors from flammable liquids will explode and catch fire causing death or severe burns

Do not use or store flammable products such as gasoline solvents or adhesives in the same room or area near the water heater.

Installation: Do not install water heater where flammable products will be stored or used such as a garage, basement, storage area or utility room unless the main burner and pilot flames are at least 18" above the floor. This will reduce, but not eliminate, the risk of vapors being ignited by the main burner or pilot flame.

Read and follow water heater warnings and instructions.
If owners manual is missing, contact the retailer or manufacturer.

Keep flammable products:

1. far away from heater,
 2. in approved containers,
 3. tightly closed and
 4. out of children's reach.
- Water heater has a main burner and pilot flame.

The pilot flame:

1. is on all the time and
2. will ignite flammable vapors

Vapors:

1. cannot be seen,
2. are heavier than air,
3. go a long way on the floor and
4. can be carried from other rooms to the pilot flame by air currents.



DANGER

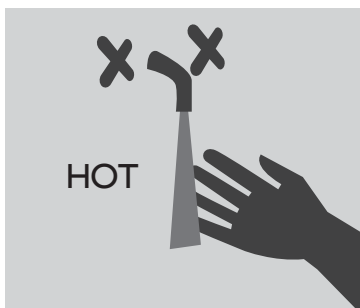

Water temperature over 125° F can cause severe burns instantly or death from scalds.

Children, disabled and elderly are at highest risk of being scalded.
See instruction manual before setting temperature at water heater.
Feel water before bathing or showering.
Temperature limiting valves are available, see manual.



 **WARNING**



Read and understand instruction manual and safety messages before installing, operating or servicing this water heater

Failure to follow instructions and safety messages could result in death or serious injury.

Instruction manual must remain with water heater.

 **WARNING**

Fire Hazard



For continued protection against risk of fire:

- . Do not install water heater on carpeted floor.
- . Do not operate water heater if flood damaged.

 **DANGER**

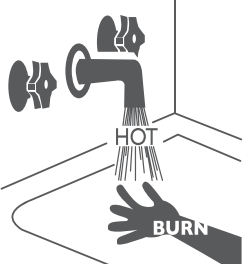

Water temperature over 125°F (52°C) can cause severe burns instantly resulting in severe injury or death.

Children, the elderly, and the physically or mentally disabled are at highest risk for scald injury.

Feel water before bathing or showering.

Temperature limiting valves are available.

Read instruction manual for safe temperature setting.

 **WARNING**

Explosion Hazard

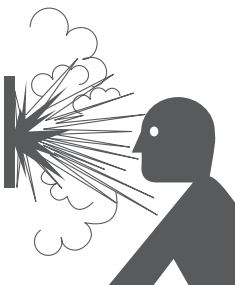



- . Overheated water can cause water tank explosion.
- . Properly sized temperature and pressure relief valve must be installed in opening provided.

 **WARNING**

Fire or Explosion Hazard

- . Do not store or use gasoline or other flammable vapors and liquids in the vicinity of this or any other appliance.
- . Avoid all ignition sources if you smell LP gas.
- . Do not expose water heater control to excessive gas pressure.
- . Use only gas shown on rating plate.
- . Maintain required clearances to combustibles.
- . Keep ignition sources away from faucets after extended period of non-use.

Read instruction manual before installing, using or servicing water heater.

 **WARNING**

Breathing Hazard - Carbon Monoxide Gas



- . Install vent system in accordance with codes.
- . Do not operate water heater if flood damaged.
- . High altitude orifice must be installed for operation above 7,700 feet (2,347m).
- . Do not operate if soot buildup.
- . Do not place chemical vapor emitting products near water heater.
- . Gas and carbon monoxide detectors are available.

Breathing carbon monoxide can cause brain damage or death.
Always read and understand instruction manual

CAUTION

Improper installation and use may result in property damage.

- . Do not operate water heater if flood damaged.
- . Inspect and replace anode.
- . Install in location with drainage.
- . Fill tank with water before operation.
- . Be alert for thermal expansion.

Refer to instruction manual for installation and service.

 **WARNING**

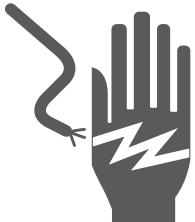

- . Before servicing the water heater, make sure the blower assembly is unplugged or the electrical supply to the water heater is turned "OFF".
- . Label all wires prior to disconnection when servicing controls. Wiring error can cause improper and dangerous operation. Verify proper operation after servicing.
- . Failure to do this could result in death, serious bodily injury, or property damage.

TABLE OF CONTENTS

WARNINGS	A
WARRANTY LIMITATIONS, CONSUMER RESPONSABILITIES, PRESSURE BUILD-UP, GENERAL, INSTALLATION	1 3
DRAFTHOOD LOCATION, VENTING	6
WATER CONNECTIONS & GAS PIPING	7
TYPICAL INSTALLATION	8
SINGLE COMMERCIAL GAS MODEL TOP CONNECTIONS WITH RETURN CIRCULATION	9
AIR SUPPLY, ALL AIR FROM INSIDE THE BUILDING	10
ALL AIR FROM OUTDOORS	11
DISCHARGE OF PURGED GASES, VENTING	12
INSTALLATION SAFETY WARNING L.P. UNITS, ANODES, MULTIPLE HEATER INSTALLATION	13
TEMPERATURE AND PRESSURE RELIEF VALVE	15
FILLING HEATER WITH WATER	16
INSTALLATION CHECKLIST	17
NATURAL GAS MODELS, L.P. GAS MODELS	18
INSTRUCTIONS FOR CLEANING TANK, TO RETURN WATER HEATER TO OPERATION	19
COMBINATION SPACE HEATING / POTABLE WATER HEATING SYSTEM, VENTING SYSTEM INSPECTION	20
OPERATING INSTRUCTIONS	21
TO TURN OFF GAS TO APPLIANCE, WATER TEMPERATURE REGULATION,TEMPERATURE CONTROL	22
GAS PRESSURE, EMERGENCY SHUTDOWN INSTRUCTIONS, TAMPERING, MAINTENANCE	23
PILOT AND MAIN BURNER, WATER HEATER SOUNDS, DRAINING	24
REPLACING BURNER ASSEMBLY, PILOT ASSEMBLY REPLACEMENT	25
COMMON COMPLAINTS	26
REPLACEMENT PARTS LIST	28
REPLACEMENT PARTS ILLUSTRATION	29
COMBINATION SPACE HEATING / POTABLE WATER HEATING SYSTEM	30

WARRANTY LIMITATIONS

THE MANUFACTURER OF THIS WATER HEATER WILL NOT BE RESPONSIBLE FOR TANK FAILURES OR WATER HEATER FAILURES RESULTING FROM ANY OF THE FOLLOWING CONDITIONS AND MAY AT ITS DISCRETIONS VOID THE WATER HEATER WARRANTY WHEN THESE CONDITIONS RESULT IN PREMATURE FAILURES OF THE TANK OR COMPONENTS

1. INSTALLATIONS NOT COMPLYING WITH ALL LOCAL CODES.
2. FAILURES DUE TO UNDERSIZING OF THE WATER HEATER AND SUBSEQUENT EXCESSIVE BURNER FIRING.
3. BAD WATER CONDITIONS SUCH AS WELL WATER WITH EXCESSIVE MINERAL DEPOSITS. IT IS THE RESPONSABILITY OF THE INSTALLER TO TAKE WHAT EVER STEPS ARE REQUIRED INCLUDING THE INSTALLATION OF WATER HEATER SOFTENERS, TO PREVENT EXCESSIVE LIME BUILD UP AND SUBSEQUENT METAL FATIGUE DUE TO OVER HEATING OF THE TANK BOTTOM AND TO USE THE HAND HOLE CLEANOUT PROVIDED IN THIS WATER HEATER TO KEEP LIME DEPOSITS IN THE TANK BOTTOM EXCEEDING FROM 2" HEIGHT.
4. INSTALLATION OF MULTIPLE WATER HEATERS IN LINE RATHER THAN PARALLEL RESULTING IN EXCESS FIRING AND/OR EXCESSIVE CONDENSATIONS ON FIRST HEATER IN SERIES OR OUT OF BALANCE PILOT OUTAGES AND PREMATURE FAILURE OF BURNER COMPONENT PARTS WILL OCCUR.
5. FAILURE TO PROVIDE ADEQUATE COMBUSTION AIR AND A CONTAMINATED AIR OUTLET OR TO ADEQUATE PROPER VENTING RESULTING IN NEGATIVE AIR PRESSURE DUE TO IMPROPER LOCATION OR LACK OF COMBUSTION SHOWN ON OWNERS OPERATION MANUAL AND THE INSTALLATION IN COMPLIANCE WITH UNIFORM PLUMB CODE.
6. FAILURE TO INSTALL HEATERS TO MANUFACTURE AND BUILDING SAFETY STANDARDS WILL CAUSE PREMATURE FAILURE OF COMPONENT PARTS, HAZARDOUS CONDITIONS AND FAILURE OF THE HEATER OR COMPONENTS CAUSED BY CHEMICALS OR SOLVENTS BEING STORED IN THE IMMEDIATE VICINITY OF THE WATER HEATER.
7. FAILURE TO PROVIDE A PROPERLY SIZED EXPANSION TANK ON THE COLD WATER LINE ON A CLOSED SYSTEM.
8. FAILURE ADEQUATE GAS SUPPLY AND PROPER PRESSURE AS OUTLINED ON OWNERS OPERATION MANUAL INSTALLED IN COMPLIANCE WITH UNIFORM PLUMBING CODE.
9. FAILURE TO INSTALL TEMPERATURE PRESSURE RELIEF VALVE DRAIN AS PER OWNERS OPERATION MANUAL AND IN COMPLIANCE WITH UNIFORM PLUMBING CODE.
10. FAILURE TO INSTALL ELECTRIC IN COMPLIANCE TO OPERATION MANUAL AND TO NATIONAL ELECTRIC CODE.

CONSUMER RESPONSIBILITIES

THIS MANUAL HAS BEEN PREPARED TO ACQUAINT YOU WITH THE INSTALLATION, OPERATION AND MAINTENANCE OF YOUR GAS WATER HEATER AND TO PROVIDE IMPORTANT SAFETY INFORMATION. WE URGE YOU TO READ ALL INSTRUCTIONS THOROUGHLY BEFORE ATTEMPTING INSTALLATION OR OPERATION OF YOUR WATER HEATER. KEEP THESE INSTRUCTIONS FOR FUTURE REFERENCE.

The manufacturer of this water heater will not be liable for any damages caused by failure to comply with the installation and operating instructions outlined on the following pages. These instructions are a guide for the correct installation of your water heater. If you lack the necessary skills required or have difficulty following the directions, you should not proceed but get help from a qualified person for that part of the installation you do not understand. Your gas-fired water heater is design-certified by ETL. The installation should conform with the local code or the authority having jurisdiction, or in the absence of such, the National Gas Code. ANSI Z223.1 NFPA 54. A copy of the Code can be purchased from American Gas Association Order Processing, 400 N. Capital St. N.W. Washington D.C. 20001 e-mail ordering: www.aga.org Fax ordering: 866-8 16-9444. A rating plate identifying your water heater will be found next to the gas control valve (thermostat).

PRESSURE BUILD-UP IN CLOSED WATER SYSTEMS

The water utility supply meter may contain a check valve, back flow preventer or water pressure reducing valve. This will create a closed water system. During the heating cycle of the water heater, the water expands creating a pressure build up in the water system. A temperature and pressure relief valve must be installed on the water heater (150 PSI maximum pressure setting. See Temperature and Pressure Relief Valve). To prevent the temperature and pressure relief valve from discharging hot water, loss of energy, and reduce the possible build-up of lime on the temperature and pressure relief valve seat.

WARNING CLOSED WATER SYSTEMS

If the water supply system contains a check valve, back flow preventer or water pressure reducing valve you will have closed water system and the pressure will build up during the water heating cycle. The temperature and pressure relief valve on the water heater will leak during the water heating cycle resulting in loss of energy. To prevent the build up of lime in the T&P valve and damage to the water heater by pressure surges you must install an expansion tank on the cold water supply line. The thermal expansion tank should have a minimum capacity of 4.5 U.S. gallons. It requires both T&P valves and expansion tanks for closed system.

Multiple water heating system and/or a system with additional storage tank must be sized by thermal expansion tank manufacturer.

WARNING

FAILURE TO PROVIDE AN EXPANSION TANK ON THE COLD WATER LINE ON A CLOSED SYSTEM WILL VOID THE WARRANTY ON THE WATER HEATER.

FOR YOUR SAFETY

Do not use or store gasoline or any other flammable vapors, liquids, or materials in vicinity of this or any other appliance.

FOR YOUR SAFETY - WHAT TO DO IF YOU SMELL GAS

- . Do not try to light any appliance.
- . Do not touch any electrical switch; do not use any phone in your building.
- . Immediately call your gas supplier from a neighbor's phone. Follow the gas supplier's instructions.
- . If you cannot reach your gas supplier, call the fire department.



WARNING

Improper installation, adjustment, alteration, service or maintenance can cause injury or property damage. Refer to this manual. For assistance or additional information consult a qualified installer, service agency or the gas supplier.

Please complete the following information at the time of installation. This should be retained and presented along with the warranty in the event a claim is necessary.

MODEL NUMBER: _____ TYPE: _____

SERIAL NUMBER: _____

INSTALLATION ADDRESS: _____

THIS WATER HEATER HAS BEEN INSTALLED IN ACCORDANCE WITH THESE INSTALLATION INSTRUCTIONS AND LOCAL CODE REQUIREMENTS ON _____

DATE

INSTALLER: _____

THIS WATER HEATER MUST BE PROPERLY AND REGULARLY MAINTAINED.
FAILURE TO DO SO WILL VOID THE WARRANTY.



IMPORTANT

BEFORE PROCEEDING WITH THE INSTALLATION OF THIS WATER HEATER, READ AND THOROUGHLY UNDERSTAND THESE INSTALLATION AND OPERATION INSTRUCTIONS. IF THERE ARE ANY QUESTIONS, THIS INSTALLATION SHOULD BE PERFORMED BY A QUALIFIED SERVICE PERSON.

GENERAL

INSPECT SHIPMENT: Inspect water heater for possible damage. If damaged, notify carrier immediately. Check markings on rating plate to make certain it corresponds with your application.

Read these instructions thoroughly before proceeding with the installation of this new gas-fired water heater. If there is any difficulty understanding all or any part of these instructions, it is recommended that a qualified service person perform the installation.

NOTICE: The manufacturer's warranty does not cover damage or injury cause by the use of any energy-saving devices (other than those authorized by the manufacturer) in conjunction with this water heater. The use of unauthorized energy-saving devices may decrease the life of the water heater and endanger life and/or property. The manufacturer will not be held liable for loss or injury resulting from the use of any unauthorized device in conjunction with this water heater.

This water heater has been equipped for use with one type of gas only. Compare the information provided on the rating plate affixed to the front of the water heater, making sure that the gas stated on the rating plate is the same as the gas to be used. **DO NOT ATTEMPT TO USE THIS WATER HEATER WITH ANY GAS OTHER THAN THE TYPE LISTED ON THE RATING PLATE.** Do not attempt to convert this water heater for use with a gas other than the type for which it is equipped. Failure to use the proper gas can create an unsafe condition resulting in property damage, bodily injury or death. Consult local gas supplier or gas company if there are any questions.

For installations in high altitude regions, this water heater must be ordered from the supplier to the manufacturer's specifications for that particular altitude. Contact the company listed on the rating label when ordering high altitude constructed water heaters.

For any questions not covered in this booklet, contact your dealer or write to us at the address shown the rating plate affixed to the front of the water heater.

This water heater has been designed and manufactured for the express purpose of heating and storing potable water and space heating. See page 23 for space heating instructions. Any use other than this purpose will release the manufacturer from any liability or warranty claims stemming from the issue of this product. Consult local authorities.



CAUTION

DO NOT STORE OR USE FLAMMABLE LIQUIDS, VAPORS, OR MATERIALS IN THE VICINITY OF THIS OR ANY OTHER APPLIANCE.

For installation on combustible flooring, the tank leg thermal break piece identified as part No. 13 on the replacement parts illustration must be installed under each leg.



INSTALLATION

Location- Select a location accessible to water lines, gas supply (type identified on the rating plate), an adequate open drain, and as close as practical to a chimney or gas vent. When installed, the water heater must be level. To prevent excessive heat loss through water piping, locate the water heater as close as practical to the areas of greatest hot water usage. Do not locate the water heater where lines could be subjected to freezing temperatures.

Adequate clearances shall be provided for easy access to controls by service personnel to enable proper cleaning, servicing and operation of the water heater. Under no circumstances is the front of the water heater to be placed in a position where the burner tray assembly cannot slide out for removal when servicing.

Clearance/Flooring- If the water heater is installed directly on carpeting, it must be installed on a metal or wood panel which extends beyond the full width and depth of the water heater by at least 3 inches in any direction. If the water heater is installed in an alcove, the entire floor must be covered by the panel. A minimum of 24 inches front clearance shall be provided for inspection and servicing.

This water heater may be installed in an alcove on combustible flooring with clearances from combustible materials as shown in Figures 1 and 2.

CAUTION

The National Fuel Gas Code (ANSI Z223.1 /NFPA 54) expressly prohibits the following:

- a) Installation of a water heater in a bathroom, bedroom, or any occupied room normally kept closed.
- b) Installation of a water heater in a garage, unless the unit is installed so that the burner and ignition devices are at least eighteen (18) inches above floor level and protected to avoid damage by moving vehicle. See Figure 3.

CLEARANCES FROM COMBUSTIBLE CONSTRUCTION

	A	B	C	D
75-76				
100-83				
G75-T2				
G100-T2	18"	2"	6"	6"

Figure 1

REMEMBER: Flammable vapors may be drawn to this water heater from other areas of the structure by air currents.

NOTE: HEATER SHALL BE LOCATED OR PROTECTED SO IT IS NOT SUBJECT TO PHYSICAL DAMAGE BY MOVING VEHICLES OR AREA FLOODING.

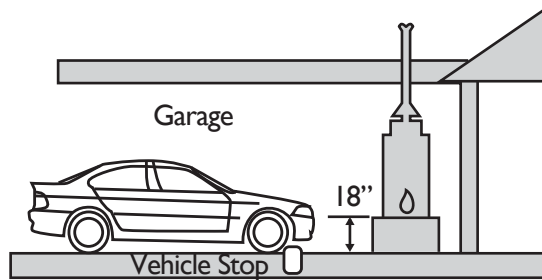

Figure 3

Typical Installation in Residential Garages (Illustration copyright by the American Gas Association. Used by permission of the copyright holder.)

CERTIFIED FOR ALCOVE INSTALLATION

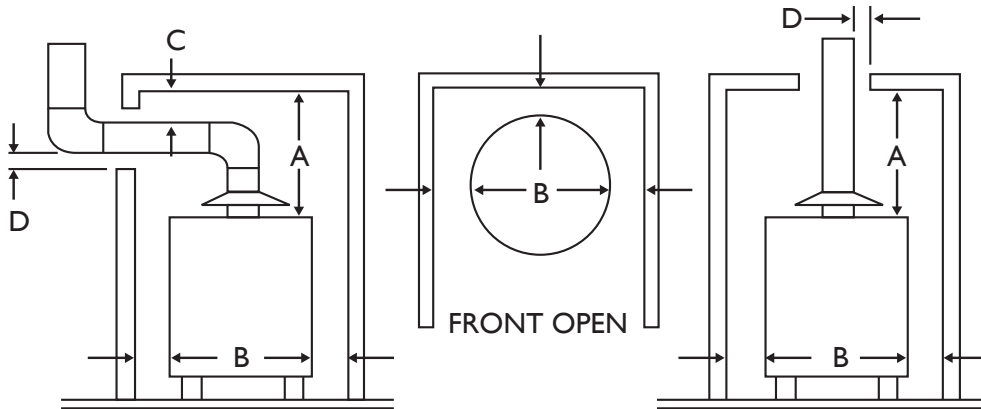

Figure 2

CERTIFIED FOR INSTALLATION ON COMBUSTIBLE FLOOR

Combustion and Ventilation Air- Provisions must be made for adequate combustion and ventilation air. Details outlining proper air supply for various types of installation are prescribed by the National Fuel Gas Code (ANSI Z-223.1/ NFPA 54) latest edition. If the water heater is installed in unconfined space within the building, infiltration air may be adequate for proper combustion and ventilation. Buildings of tight construction (weather stripping, caulked, etc.) require additional air from outdoors.

If the water heater is installed in a confined space (volume is less than 50 cu. ft. per 1000 BTUH of the total input rating of all gas appliances in that space), air must be supplied through two permanent openings. One opening shall be within 12 inches from the top of the enclosure and one within 12 inches of the bottom. The openings must be protected by metal louvers or 1/4" min. mesh metal screen.

The size of the openings are as follows:

1.- If the openings communicate directly with an additional room(s) of sufficient volume, each opening shall have a minimum free area opening of 1 sq. in. per 1000 BTUH of the total input rating of all gas appliances in the confined space, but not less than 100 sq. inches.

2.- If the openings communicate directly with the outdoors or through vertical ducts with the outdoors, each opening shall have a minimum free area of 1 sq. in. per 4000 of the total rating of all gas appliances in the enclosure.

3.- If the openings communicate with the outdoors through horizontal ducts, each opening shall have a minimum free area of 1 sq. in. per 2000 BTUH of the total rating of all gas appliances.

CAUTION

The draft diverter relief opening of the water heater and the combustion air inlet must be in the same atmospheric pressure zone. Large exhaust fans in kitchens or other locations can lower the air pressure inside an enclosure and interfere with proper operation and venting of the water heater. In these cases, the water heater should be installed in a separate room with combustion and ventilation air supplied directly from outdoors as previously described.

Corrosive Atmosphere- Water heater corrosion and component failure can be caused by the heating and breakdown of airborne chemical vapors. Spray can propellants, cleaning solvents, refrigeration and air conditioning refrigerants, swimming pool chemicals, calcium and sodium chloride, waxes, and process chemicals are typical compounds which are potentially corrosive. These materials are corrosive at very low concentration levels with little or no odor to reveal their presence.

Products of this sort must not be stored near the water heater, nor should air which is brought in contact with the water heater contain any of these chemicals. Flammable vapors may be drawn by air currents from other areas of the structure to this appliance. If necessary, uncontaminated air should be obtained from remote or outside sources.

THE WARRANTY ON THIS WATER HEATER DOES NOT COVER DAMAGE CAUSED FROM OPERATION IN A CORROSIVE ATMOSPHERE.

Water Damage/Drain Pan- The water heater should be located in an area where leakage of the tank or connections will not result in damage to the area adjacent to the water heater or to lower floors of the structure. **WHEN SUCH LOCATIONS CANNOT BE AVOIDED, A SUITABLE DRAIN PAN MUST BE INSTALLED UNDER THE WATER HEATER HAVING A LENGTH AND WIDTH AT LEAST 3 INCHES GREATER THAN THE DIAMETER OF THE WATER HEATER, A MAXIMUM HEIGHT OF 1-3/4 INCHES, AND BE PIPED TO AN OPEN DRAIN. DO NOT RESTRICT THE FLOW OF COMBUSTION AIR.**

DRAFTHOOD LOCATION

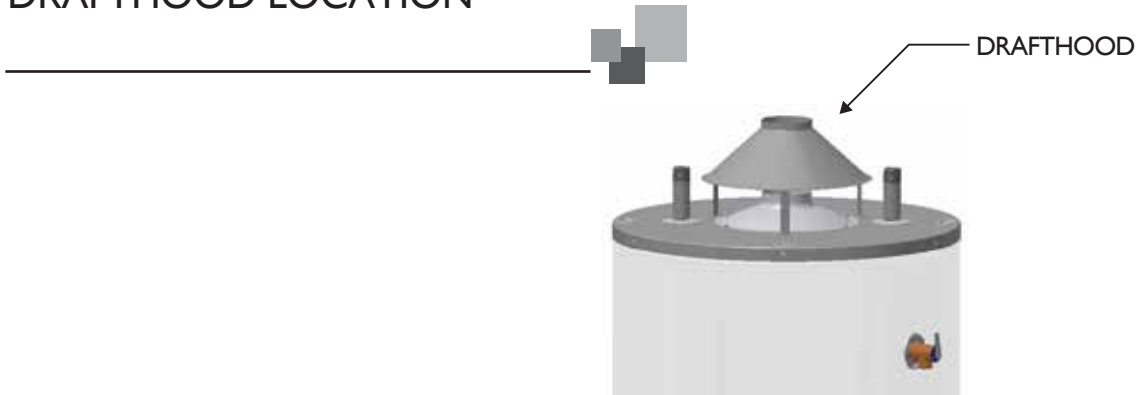

Figure 4

DRAIN PAN INSTALLATION AND CONSTRUCTION MUST CONFORM TO LOCAL CODES AND ORDINANCES. IF NOT INSTALLED AND OPERATED IN ACCORDANCE WITH THESE INSTRUCTIONS, UNDER NO CIRCUMSTANCES WILL THE MANUFACTURER OF THIS WATER HEATER BE LIABLE FOR ANY WATER DAMAGE OR INJURY IN CONNECTION WITH THIS WATER HEATER.

VENTING

IMPORTANT NOTICE

This water heater may be installed as a replacement with venting that met the existing codes at the time of the installation of the original water heater.

WARNING

The installer to check the installation for venting and for spillage all around the draft hood relief opening after five minutes of operation the method to check for flue products spillage should utilize a flame or a match, or candle or smoke or flame from another source such a cigarette or grill lighter wand. The procedure used should be to play the flame or smoke around the perimeter of the draft hood from the outside.

If spillage is encountered, it would be manifested by smoke escaping away from the draft hood or by the flame being extinguished while outside of the hood. Good venting would be indicated by smoke and the flames being drawn into the draft hood.

Vent Size Model	Vent Size
75-76	
100-83	
G75-T2	4 in
G100-T2	

Draft Diverter- This water heater has been shipped with a draft diverter for which it was designed with reference to the horizontal and vertical planes. If removed, the draft diverter shall be replaced in the same position and secured to the jacket top by the screws with which it was installed.

Vent Piping- This water heater must be connected to a masonry chimney or venting system approved by local codes or ordinances. The vent connector used to attach the draft diverter outlet to the chimney or approved vent must be of the same diameter as the draft diverter outlet or larger. For proper venting in certain installations, a larger vent connector may be needed. Consult venting tables in National Fuel Gas Code ANSI Z223.1/NFPA 54 latest or current or local code officials for proper application in your area.

CAUTION

Better combustion is achieved by avoiding numerous elbows in the vent piping. Horizontal piping must be sloped upward at least 1/4 inch per linear foot of length. All connections in venting system must be securely fastened with sheet metal screws or other approved method. Check local codes and ordinances.

Failure to install a proper venting system can result in fire, injury, or death.

WATER CONNECTIONS

Installation- Refer to Figure 5 for typical installation. Connect the hot and cold water supply to the water heater, hot to the location marked "HOT" and cold to the location marked "COLD". Note: If making cold water connection on top, determine that the dip tube is in place. If sweat connections are used, sweat tubing to adapter before attaching adapter to the top cold water inlet as it may contain a nonmetallic dip tube. When making these connections, use a good grade of pipe joint compound. Be familiar with the location of the shut-off valve in the cold water line feeding the water heater (See Figure 5). If a valve is not present, one shall be installed as shown in Figure 5.

Do not install a check valve or other device that would prevent reverse flow of water ("closed system") unless required by local codes. A closed system will result in frequent operation of the relief valve. Provisions must be made for protection against thermal expansion in the event of a closed system (Page 1). Warranties do not cover pressure bulges and/or deformities.

This water heater is capable of delivering high temperature hot water at any faucet in the system. Care must be taken whenever using hot water to avoid scalding injury. Certain appliances require high temperature hot water (such as dishwashers and automatic clothes washers). In order to prevent potential scald injury, install an anti-scald tempering valve in the water system.

GAS PIPING

Use clean black iron pipe or equivalent material approved by local codes and ordinances for gas piping. Install a ground-joint-union in the supply line as close to the water heater as possible. A manual gas shut-off valve should be above floor level and readily accessible. A drip leg (consisting of a pipe tee, 4 inch nipple, and a cap) should be installed as shown in Figure 5.

Make sure the gas supplied to the heater is the same type as listed on the rating plate. **DO NOT ATTEMPT TO USE THIS WATER HEATER WITH ANY GAS OTHER THAN THE TYPE LISTED ON THE RATING PLATE.**

Compound used for the connection of all gas piping should be resistant to the action of liquefied petroleum (L.P.) gases. Apply pipe dope sparingly to the male threads only. **DO NOT** apply pipe dope to the gas valve inlet. Make certain that no pipe dope has become lodged in the inlet screen of the gas valve. This will restrict the flow of gas. When attachment of gas piping to gas valve inlet is made, extreme care must be taken to prevent pipe dope from entering the gas valve inlet and to avoid excessive torque to prevent cracking of the gas valve inlet housing. The suggested maximum torque is 31.5 ft. lbs. The manufacturer of this water heater will not be liable for any damage or injury caused as a result of a cracked gas inlet from excessive torque.

TYPICAL INSTALLATION

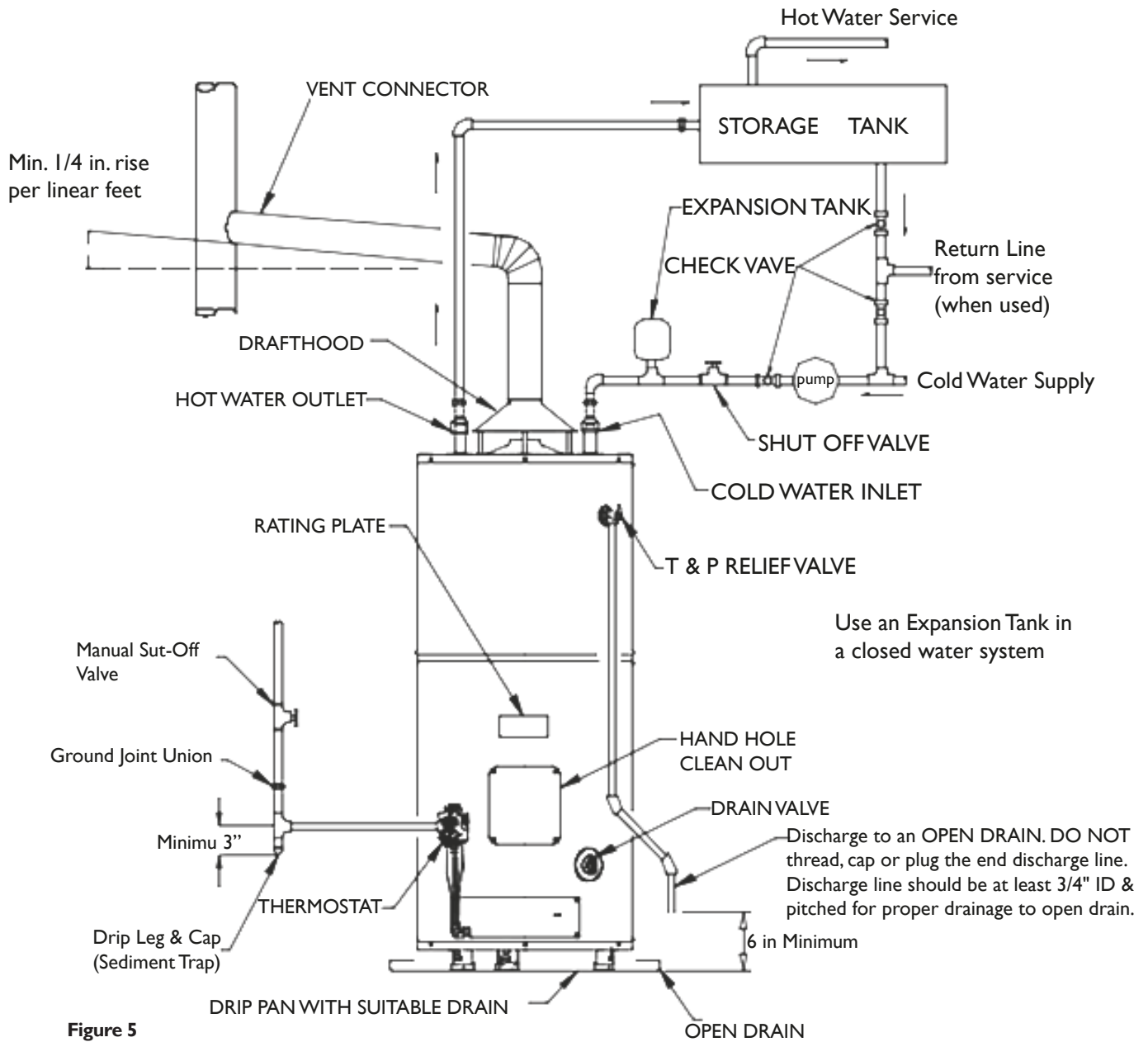
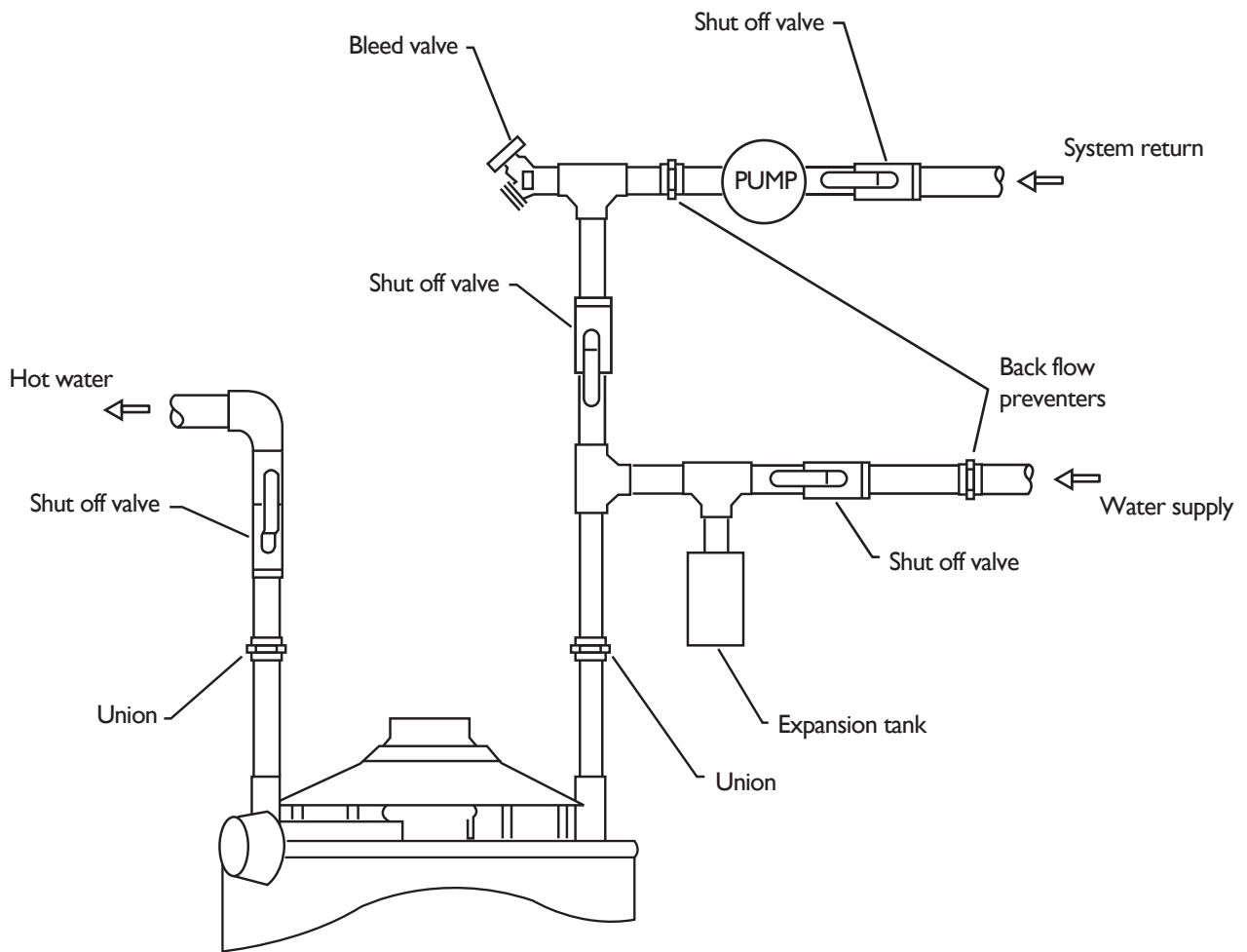

Figure 5

SINGLE COMMERCIAL GAS MODEL TOP CONNECTIONS WITH RETURN CIRCULATION



AIR SUPPLY

Important air for combustion and ventilation must not come from a corrosive atmosphere. Any failure due to corrosive elements in the atmosphere is excluded from warranty coverage.

The following types of installation (not limited to the following) will require outdoor air for combustion due to chemical exposure and may reduce but not eliminate the presence of corrosive chemicals in the air.

- . Beauty shops.
- . Photo processing labs.
- . Buildings with indoor pools
- . Water heaters installed in laundry, lobby or craft rooms.
- . Water heaters installed in chemical storage areas.

Combustion air must be free of acid-forming chemicals such as sulfur, fluorine, chlorine. These elements are found in aerosol sprays, detergents, bleaches, cleaning solvents, air fresheners, paint and varnish removers, refrigerants, and many other commercial or household products. When burned, vapors from these products form highly corrosive acid compounds. These products should not be stored or used near the water heater or air inlet.

Combustion and ventilation air requirements are determined by the location of the water heater. The water heater may be located in either an open (unconfined) area or in a confined area or small enclosure, such as a closet or small room. Confined spaces are areas with less than 50 sq.ft.

ALL AIR FROM INSIDE THE BUILDING

The confined space shall be provided with two permanent openings communicating directly with an additional room(s) of sufficient volume so that the combined volume of all spaces meets the criteria for an unconfined space shall be considered in making this determination. Each opening shall have a minimum free area of 1 square inch per 1,000 BTU per hour of the total input rating of all gas utilization equipment in the confined space, but not less than 100 square inches.

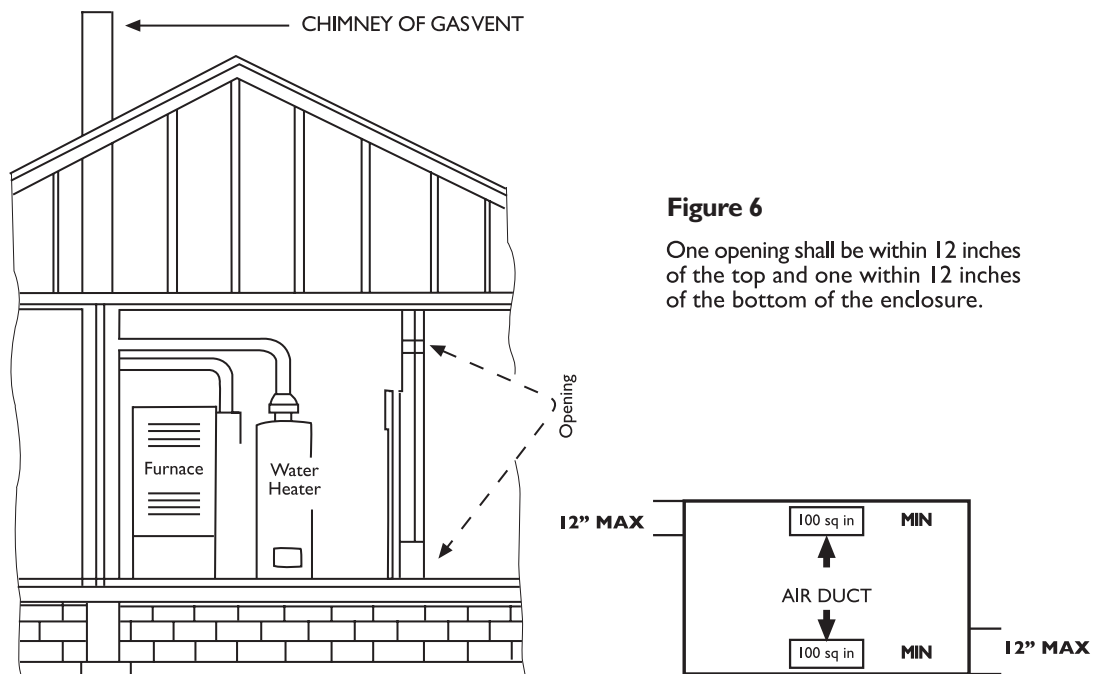

Figure 6

One opening shall be within 12 inches of the top and one within 12 inches of the bottom of the enclosure.

ALL AIR FROM OUTDOORS

The confined space shall be provided with two permanent openings, one commencing within 12 inches of the top and one commencing within 12 inches of the bottom of the enclosure. The openings shall communicate directly, or by ducts, with the outdoors or spaces (crawl or attic) that freely communicate with the outdoors.

When directly communicating with the outdoors each opening shall have a minimum free area of 1 square inch per 4,000 BTU per hour of total input rating of all equipment in the enclosure. (Figure 7)

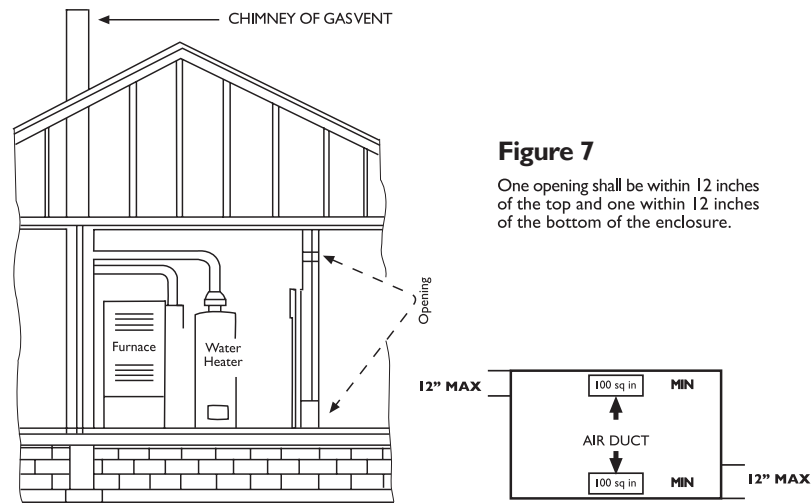

When communicating with the outdoors through vertical ducts, each opening shall have a minimum free area of 1 square inch per 4,000 BTU per hour of total input rating of all equipment in the enclosure. (figure 8)

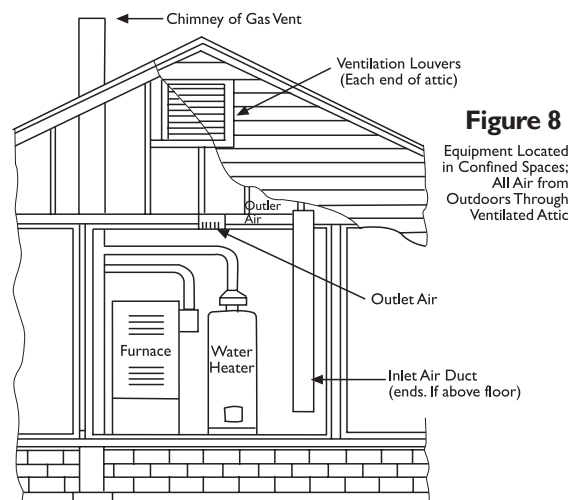

1. When communicating with the outdoors through horizontal ducts, each duct opening shall have a minimum free area of 1 square inch per 2,000 BTU per hour of total input rating of all equipment in the enclosure. (figure9)

When ducts are used, they shall be of the same cross-sectional area as the free area of the openings to which they connect. The minimum dimension of the rectangular air ducts shall not be less than 3 inches. For other combustion and ventilation air openings, refer to the National Fuel Gas Code ANSI Z223.1.*

NOTE: If the equipment room is located against an outside wall and the air openings communicate directly with the outdoors, each opening shall have a free area of not less than one square inch per 4,000 BTU per hour of the total input rating of all equipment in the enclosure.

Illustration for Figures 6-9 copyright by the American Gas Association. Used by permission of the copyright holder.

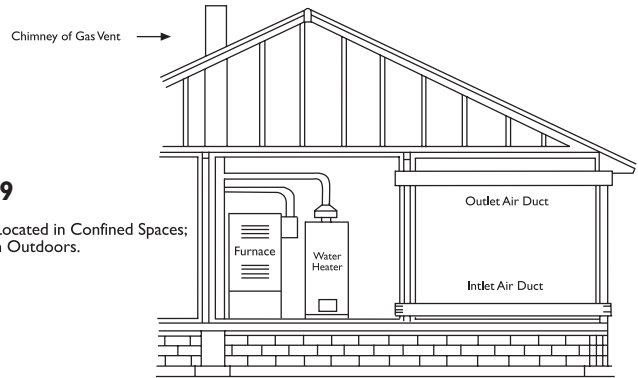

Figure 9
Equipment Located in Confined Spaces;
All Air From Outdoors.

DISCHARGE OF PURGED GASES

When removing purged gases from a piping system, care should be taken to not create hazardous condition, such as discharging the gases into a confined area or in an area which contains an ignition source.

VENT PIPE SYSTEM

The water heater must be connected to the chimney. The vent pipe from the heater to the chimney (vent connector) must be no less than the diameter of the draft hood outlet on the heater and should slope upward to the chimney at least 1/4 inch per linear foot.

Due to great variances in installations, unforeseeable by the manufacturer of the water heater, increased size vent connectors and pipes may be necessary for proper venting.

Consult your local utility. They will aid you in determining the proper venting for your heater from the vent tables in the American National Standard Z223.1 (NFPA 54) "National Fuel Gas Code"

There are various types of vent dampers currently available. Some of these vent dampers are certified by the Canadian Standard Association Laboratories. The certifications apply to the vent damper device only and do not mean they are certified for use on this water heater. The use of these devices is not permitted by the manufacturer of this water heater.

VENTING

IMPORTANT NOTICE

This water heater may be installed as a replacement with venting that met the existing codes at the time of the installation of the original water heater.

This water heater uses a non-direct, single-pipe vent system to remove exhaust gases created by the burning of fossil fuels. Air for combustion is taken from the immediate water heater location or is ducted in from the outside (see "Combustion Air Supply and Ventilation").

This water heater must be properly vented for the removal of exhaust gases to the outside atmosphere. Correct installation of the vent pipes system is mandatory for the proper and efficient operation of this water heater and is an important factor in the life of the unit.

U.L. approved fuel gas and carbon monoxide (CO) detectors are recommended in all applications and should be installed using the manufacturer's instructions and local codes, rules, or regulations.

Important: If you lack the necessary skills required to properly install this venting system, you should not proceed, but get help from a qualified service technician.

MECHANICAL EXHAUSTING AND FIREPLACES

the operation of air-moving devices such as exhaust fans, ventilation system, clothes dryers fireplaces, etc. can affect the proper operation of gas utilization equipment.

Consequently, special attention must be given to conditions these devices may create to avoid unsatisfactory operation of the equipment.

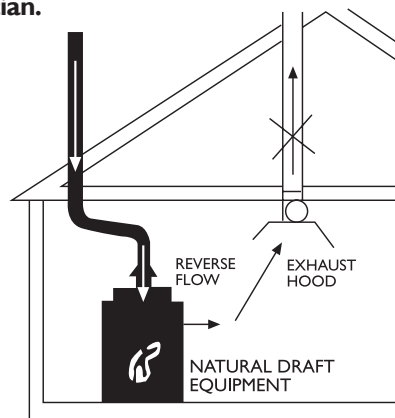

POTENTIAL HAZARDOUS DOWNDRAFT OPERATION

- . EXHAUST FANS
- . VENTILATION SYSTEM
- . CLOTHES DRYERS
- . FIREPLACES
- . OTHERS



After completing all gas connections, check each gas connection and fitting for leaks. Use a soap and water solution or a commercial leak detector fluid. **NEVER USE MATCHES OR OPEN FLAME WHEN CHECKING FOR GAS LEAKS.**

The water heater and its individual gas shut off valve must be disconnected from the gas supply piping system during any pressure testing or that system at test pressures in excess of 1/2 psi (14" W.C.) or 3.5kPa.

The water heater must be isolated from the gas supply piping system by closing its individual manual shut-off valve during any pressure testing of the gas supply piping system at test pressures equal to or less than 1/2 psi (14"W.C.) or 3.5kPa.

If the gas valve is subjected to pressure exceeding 1/2 psi, the damage to the gas valve could result in an extremely hazardous condition. If this has occurred, the gas valve must be replaced. Contact your dealer for service. It is recommended that all service work be done by a qualified service agency

INSTALLATION SAFETY WARNING L.P. UNITS

Liquefied petroleum (L.P.) gas is heavier than air and will remain at floor level if there is a leak. Basements, crawl spaces, closets and areas below ground level will serve as pockets for accumulation of leaking gas. Before lighting, sniff at floor level.

IF YOU SMELL GAS, follow applicable instructions on Front Cover or Page 21, DO NOT OPERATE APPLIANCE UNTIL LEAKAGE IS CORRECTED.

CAUTION

NEVER OPERATE AN EMPTY OR PARTIALLY FILLED WATER HEATER

ANODES

This water heater is supplied with anode rods designed to extend tank life and reduce corrosion. Anodes emit a weak flow of electrical current through the water to protect the tank. When present in "highly active" water, a "rotten egg" odor may be produced from the gases from the anodes, mixing with the water. This is not the fault of the water heater. Chlorination of the water supply system should minimize this condition. (Consult your telephone directory for local water treatment specialists). **REMOVAL OF AN ANODE ROD WILL VOID THE WARRANTY.**

MULTIPLE HEATER INSTALLATION

INSTALLATION DIAGRAMS INSTALLATIONS WHERE HEATERS ARE MANIFOLDED.

All heaters should have approximately the same input rate. To manifold a high input heater with a low input heater will result in the lower input heater running excessively. It is preferable for all heaters to be the same model.

All heaters must be evenly spaced to provide identical number of turns, length and size of pipes in each manifold. This is absolutely necessary to insure a balanced condition to all heaters in the installation.

INSTALLATION (Using Top Connect Only)

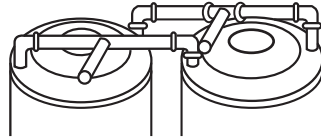

Typical installation showing two (2) Commercial Heaters in parallel manifold using top connect only.

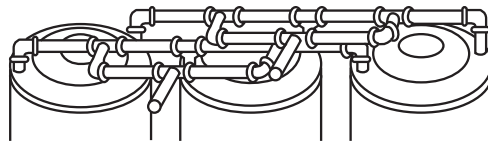

Typical installation showing three (3) Commercial Heaters in parallel manifold using top connect only.

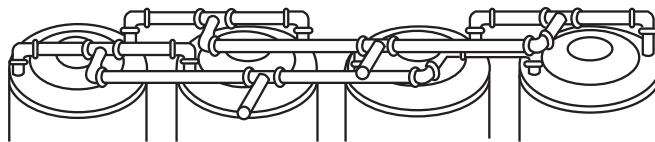

Typical installation showing four (4) Commercial Heaters in parallel manifold using top connect only.

Figure 10



WARNING

Hydrogen gas can be produced in a hot water system that has not been used for a long period of time (generally two weeks or more). **HYDROGEN GAS IS EXTREMELY FLAMMABLE.** To prevent the possibility of injury under these conditions, we recommend the hot water faucet be opened for several minutes at the kitchen sink before you use any electrical appliance which is connected to the hot water system. Do not light a cigarette, cigar or pipe. Do not smoke. If hydrogen is present, there will probably be an unusual sound such as air escaping through the faucet as the water begins to flow. Remember, no smoking or open flame near the faucet at the time it is opened.

TEMPERATURE AND PRESSURE RELIEF VALVE

For protection against excessive pressures and/or temperatures, a temperature and pressure relief valve must be installed in the opening marked "temperature and pressure relief valve". A design certified by a nationally recognized testing laboratory that maintains periodic inspection of production of listed equipment or materials, as meeting the requirements for Relief Valves and Automatic Gas Shut-off devices for Hot Water Supply Systems, ANSI Z21 .22. Pressure rating of the valve must not exceed the working pressure shown on the rating plate of the water heater. Relief piping must terminate 6 inches above a floor drain or external to the building. Do not thread, cap, or plug the end of this discharge line. Be certain that no contact is made with any live electrical part. Do not connect discharge line directly to drain. (Figure 5)

To prevent bodily injury, hazard to life or damage to property, the relief valve must be allowed to discharge water in the event of excessive temperature or pressure developing in the water heater. The function of the temperature and pressure relief valve is to discharge water in large quantities should circumstances demand. If the discharge pipe is not directed to a drain as shown in Figure 5, or other suitable means, the water flow may cause property damage.

The discharge line:

- (1) Must not be smaller than the pipe size of the relief valve,
- (2) Must not be plugged or blocked,
- (3) Must be of material capable of withstanding 210°F without distortion,
- (4) Must be installed so as to allow complete drainage of both the temperature and pressure relief valve and discharge line,
- (5) Must terminate at an adequate drain (Figure 5)
- (6) Must not have any valve between the relief valve and the end of the discharge line.

Failure to install and maintain a new properly listed temperature and pressure relief valve will release the manufacturer from any claim which might result from excessive temperature or water pressure.

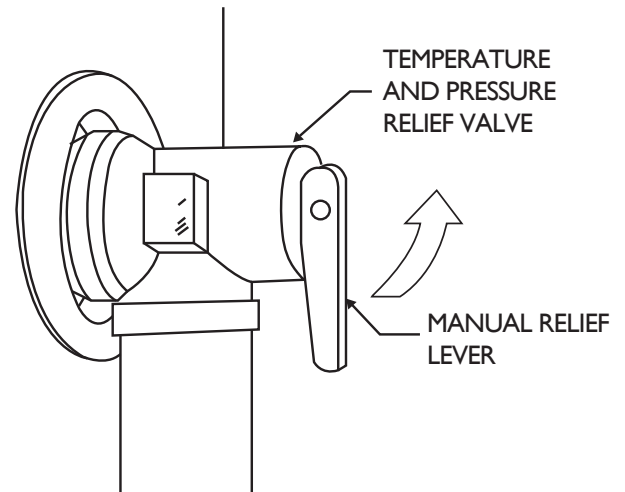

Figure 11 DISCHARGE LINE TO DRAIN

WARNING

Do not attempt to operate this water heater with the cold water inlet valve closed. Manually operate the pressure-temperature relief valve at least once a year. To prevent water damage, discharge line must terminate at an adequate drain. Standing clear of the outlet (discharge water may be hot), lift and release the lever handle on the pressure-temperature relief valve to make the valve operate freely.

If the temperature and pressure relief valve on the appliance discharges periodically, this may be due to thermal expansion in a closed water supply system (see "Pressure Build-Up in Water System" -Page 1). Contact the water supplier or local plumbing inspector on how to correct this situation. Do not plug the temperature and pressure relief valve.



WARNING

TO AVOID POSSIBLE INJURY, FIRE AND EXPLOSION, READ THESE PRECAUTIONS BEFORE ATTEMPTING TO LIGHT OR RELIGHT THE PILOT. Check the rating plate near the gas control thermostat for correct gas. DO NOT USE THIS WATER HEATER WITH ANY GAS OTHER THAN THE ONE LISTED ON THE RATING PLATE (Figure 5). Failure to use the correct gas can cause problems which result in DEATH, SERIOUS BODILY INJURY, OR PROPERTY DAMAGE. If you have any questions or doubts consult your gas supplier or gas company.

FILLING HEATER WITH WATER

- 1.- Close the heater drain valve by turning the handle to the right (clockwise). The drain valve is on the lower front of heater.
- 2.- Open the cold water supply valve to the heater.
- 3.- To insure complete filling of the tank, allow air to exit by opening the nearest hot water faucet. Allow water to run until a constant flow is obtained. This will let air out of the heater and the piping.



CAUTION

Operating an empty or partially filled heater will result in damage to the tank.

- 4.- Check all new water piping for leaks. Repair as needed.
- 5.- Unit is ready to be started. Follow lighting instructions on Page 21.



INSTALLATION CHECK LIST

Before putting burner in operation

This is presented for ease of reference. It is not comprehensive. All instructions and warnings must be read and adhered to

■ A. HEATER LOCATION

- Close to area of vent.
- Indoors and protected from freezing temperatures.
- Proper clearance from combustible surfaces observed and heater not installed directly on carpeted floor.
- Sufficient fresh air supply for proper operation of heater.
- Air supply free of corrosive elements and flammable vapors.
- Provisions made to protect area from water damage.
- Sufficient room to service heater.

■ B. WATER SUPPLY (See WATER PIPING)

- Install cold water inlet valve (Figure 5)
- Heater completely filled with water.
- Water connection tight and free of leaks.

■ C. RELIEF VALVE

- Install a new Temperature and Pressure Relief Valve properly and discharge line run to open drain.
- Discharge line protected from freezing (Figure 5)

■ D. GAS SUPPLY

- Gas supply same as the type of gas listed on the rating plate.
- Gas line equipped with shut-off valve, union and drip leg (Figure 5).
- Approved pipe joint compound used.
- Soap and water solution used to check all connections and fittings for possible gas leaks.
- The installer to visually determine that the main burner flames are burning correctly without lifting, floating or flashing back and that the air
 shutters should be adjusted and locked to a position that results in correct burner flame pattern (see page 14) after to turn on water heater.

■ E. VENTING

- Draft diverter properly installed.
- Vent connector(s) securely fastened together with screws.
- Vent connector(s) at least 6" from combustible material.
- Check with spill test

NATURAL GAS MODELS

IF YOU SMELL GAS:

- 1.- Open windows.
- 2.- Get all people out of the building.
- 3.- DO NOT light matches.
- 4.- DO NOT touch electrical switches (on or off).
- 5.- Extinguish any open flames.
- 6.- Use an outside phone and immediately call the gas company and the fire department. Ask for instructions. Before hanging up, give your name and address.
- 7.- DO NOT go back into the building. If help is coming, wait for it outside of the building.

L.P. (PROPANE, BOTTLED) GAS MODELS

L.P. GAS IS HEAVIER THAN AIR

Should there be a leak in the system, the gas will settle at FLOOR LEVEL. Basements, crawl spaces, skirted areas under mobile homes (even when ventilated), closets and areas below ground level will serve as pockets for the accumulation of gas.

BEFORE LIGHTING, sniff at FLOOR LEVEL

IF YOU SMELL GAS. FOLLOW THESE RULES:

- 1.- Open windows.
- 2.- Get all people out of the building.
- 3.- DO NOT light matches. Extinguish any open flame.
- 4.- DO NOT touch electrical switches (on or off).
- 5.- SHUT OFF GAS at L.P. tank outside of the building.
- 6.- Use an outside phone and immediately call the gas company and the fire department. Ask for instructions. Before hanging up, give your name and address.
- 7.- DO NOT go back into the building. If help is coming, wait for it outside of the building.

OUT OF FUEL

When your L.P. tank runs out of fuel, turn off gas at all gas appliances including gas to pilots. After L.P. tank is refilled, all appliances must be re-lit according to the manufacturer's instructions, Page 21.

EXPOSURE TO WATER

Do not use this appliance if any part has been under water. Immediately call a qualified service technician to inspect the appliance and to replace any part of the control system and any gas control which has been under water.



DANGER

DO NOT STORE OR USE ANY COMBUSTIBLE MATERIALS OR LIQUIDS, SUCH AS GASOLINE, PAINT THINNERS OR OTHER FLAMMABLE VAPORS NEAR ANY GAS BURNING APPLIANCES. VAPORS MAY BE IGNITED BY THE PILOT OR MAIN BURNER FLAMES. NO OBSTRUCTION SHOULD BE IN THE FLOW OF COMBUSTION AND VENTILATION AIR.

INSTRUCTIONS FOR CLEANING TANK

(ONLY FOR 75-76 & 100-83 MODELS)

A clean-out procedure is provided for periodic cleaning of the tank.

1. Shut off gas supply to water heater.
2. Shut off water supply to water heater.
3. Open the nearest hot water faucet.
4. Attach hose to drain valve, and open drain valve so water can drain from water heater.



WARNING

This water can be hot.

5. Remove jacket clean-out cover from jacket (4 screws). Part No. 6 on page 29.
6. After the water heater has been drained, remove the hex head bolts and the plate will come loose. If necessary, tap lightly on the outside edge.
7. After tank has cooled, remove loose scale and lime deposits from inside tank, being careful not to break glass lining.

TO RETURN WATER HEATER TO OPERATION

1. Re-install seal
2. Re-install hand hole plate, with the hex head bolts, inserting all bolts in place before beginning final tightening. Tighten bolts, rotating on opposite sides, rather than in a continuous circular pattern.
3. Tighten water connection. Open cold water inlet valve to fill tank. When water flows in a steady even stream, close hot water faucet previously opened.
4. Turn on gas supply to heater.
5. Using lighting instructions located on jacket of heater, put heater into operation.

VACATION

When the heater is not to be used for extended periods of time (vacations, etc.) turn the temperature dial to its lowest setting. This will maintain the water at relatively low temperatures with minimum energy losses and prevent the tank from freezing during cold weather. When making adjustments to the thermostat temperature setting, refer to the section on THERMOSTAT. Also refer to Page 14 WARNING HYDROGEN GAS.

COMBINATION SPACE HEATING /POTABLE WATER HEATING SYSTEM

When using this heater as a source of heat for a combination space heating/potable water heating system, be sure to follow manual(s) shipped with air handler system. Refer to figure 16 page 30. Note the following warnings:

Toxic chemicals, such as those used for boiler treatment, shall NEVER be introduced into this system. This unit may NEVER be connected to any existing heating system or component(s) previously used with a non-potable water heating appliance.

DO NOT use with piping that has been treated with chromates, boiler seal or other chemicals.

DO NOT add boiler treatment or any chemicals to any heat piping, since the piping contains potable water.

DO NOT use with ferrous piping. The system should be installed only with new piping that is suitable for potable water, such as copper or polybutylene. DO NOT use with PVC piping.

DO NOT use with any pumps, valves, or fittings that are not completely compatible with potable water piping.

DO NOT use valves that may cause excessive restriction to water flow. USE FULL FLOW BALL OR GATE VALVES ONLY.

DO NOT tamper with the thermostat, gas valve, igniter control or temperature and pressure relief valve. Tampering with any of these components is DANGEROUS and can result in property damage or severe injury. Tampering voids all warranties. Only qualified personnel should service these components.

DO NOT use 50/50 solder in potable water lines.

IF THE SPACE HEATING system requires water temperatures in excess of 140°F, a mixing valve or other means should be installed in the domestic (potable) hot water supply to limit the RISK OF SCALD DAMAGE.

SOME JURISDICTIONS may require a backflow preventer in the incoming cold water line to the water heater. In such cases, the temperature and pressure relief valve on the water heater may weep or relieve due to expansion of the heated water. A diaphragm-type expansion tank will normally eliminate this weeping condition. Please read and follow the manufacturer's instructions for installation of such tanks.

VENTING SYSTEM INSPECTION

Check the draft hood relief opening (Figure 5) using a match flame after 15 minutes of operation. Pass the match flame around the relief opening of the draft hood. A steady flame drawn into the opening indicates proper draft. If the flame flutters or is blown out this would indicate spillage and corrective action must be made to the vent. (Figure 5)

At least every 3 months a visual inspection should be made of the venting system. You should look for:

Obstructions which could cause improper venting.

Damage or deterioration which could cause improper venting or leakage of combustion products.

CONDENSATION

Whenever the heater is filled with cold water there will usually be a certain amount of condensation formed while the burner is ON. Moisture from the products of combustion condenses on the cooler tank surfaces to produce a "sizzling" or "frying" noise. During the winter months this condition will be more pronounced. Condensation is normal and should not be confused with a leaking tank. The water will be noted at different times of the year and in varying quantities.



BEFORE PLACING THIS WATER HEATER IN OPERATION SEE "CONDENSATION" ON PREVIOUS PARAGRAPH.

FOR YOUR SAFETY READ BEFORE OPERATING



WARNING

If you do not follow these instructions exactly, a fire or explosion may result causing property damage, personal injury or loss of life.

A. This appliance has a pilot which must be lighted by hand.

B. **BEFORE OPERATING** smell all around the appliance area for gas. Be sure to smell next to the floor because some gas is heavier than air and will settle on the floor.

WHAT TO DO IF YOU SMELL GAS

- . Do not try to light any appliance.
- . Do not touch any electric switch; do not use any phone in your building.
- . Immediately call your gas supplier from a neighbor's phone. Follow the gas supplier's instructions.
- . If you cannot reach your gas supplier, call the fire department.



C. Use only your hand to push in or turn the gas valve knob.

Never use tools. If the knob will not push in or turn by hand, don't try to repair it, call a qualified service technician. Force or attempted repair may result in a fire or explosion.

D. Do not use this appliance if any part has been under water.

Immediately call a qualified service technician to inspect the appliance and to replace any part of the control system and any gas control which has been under water.

OPERATING INSTRUCTIONS

- 1.- STOP! Read the safety warnings above on this label.
- 2.- Remove outer and inner doors.
- 3.- Turn temperature dial counter-clockwise  to lowest settings.
- 4.- Turn gas control knob clockwise  to "OFF" position.
- 5.- To clear any gas that may have accumulated wait ten (10) minutes. If you then smell gas, STOP! Follow "B" in the safety warning above on this label. If you don't smell gas go to the next step.
- 6.- Find pilot – Follow the smaller metal tube from the thermostat to the pilot.
- 7.- Turn gas control knob counter-clockwise  to "PILOT" position.
- 8a.- **For Gas Natural:** Light match and hold to pilot. While holding lighted match to pilot, depress reset button all the way; hold until pilot lights. Continue to hold the button for one (1) minute after the pilot was lighted. Release the reset button and it will pop back up. Pilot should remain lit. If it goes out, repeat steps 3 through 8.

- 8b.- **For Gas LP:** Light match and hold to pilot. While holding lighted match to pilot, depress the gas control knob all the way; hold until pilot lights. Continue to hold the knob for one (1) minute after the pilot was lighted. Release the gas control knob and it will pop back up. Pilot should remain lit. If it goes out, repeat steps 3 through 8.

- If reset button/gas control knob does not pop up when released, stop and immediately shut off gas ahead of control at line valve or tank. Call your service technician or gas supplier.
- If the pilot will not stay lit after several tries, turn the gas cock clockwise  to "OFF" position and call your service technician or gas supplier.

- 9.- Replace the inner door.
- 10.- Turn gas control knob counter-clockwise  to "ON" position.
- 11.- Set temperature dial to desired setting.
- 12.- Replace outer door.

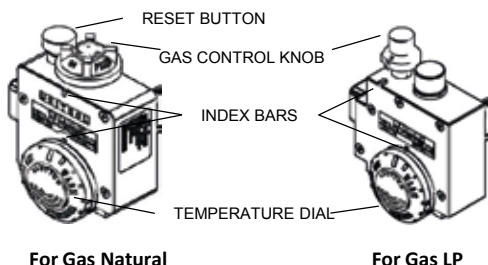

For Gas Natural

For Gas LP



Temperature Dial
Point 3 and 11

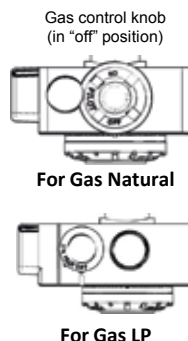

For Gas Natural

For Gas LP

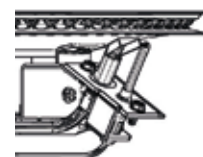

PILOT
Point 6

TO TURN OFF GAS TO APPLIANCE

1. Set the thermostat to lowest setting.
2. Turn off all electrical power to the appliance if service is to be performed.
3. Turn the gas valve knob clockwise  to "OFF" position.

WATER TEMPERATURE REGULATION

The temperature of the water in the heater can be regulated by the setting of the temperature dial on the thermostat. To adjust the temperature setting, rotate dial to desired temperature setting (Fig. 12).



DANGER

Water temperatures over 125°F can cause severe burns instantly or death from scalds. Children, disabled, and elderly are at highest risk of being scalded. Feel water before bathing or showering. Temperature limiting valves are available, and should be installed when lower outlet temperatures are required.

TEMPERATURE CONTROL

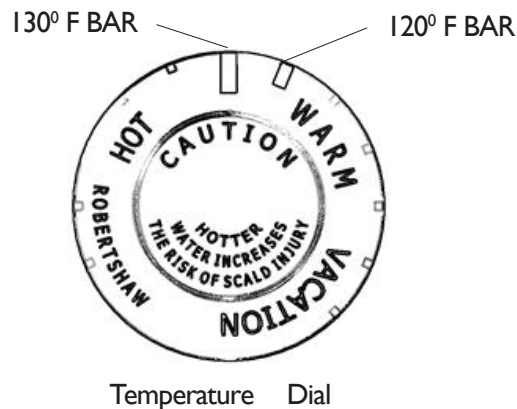

Figure 12

GAS PRESSURE

With the water heater in operation (main burner on), the maximum supply pressure must not exceed the specified value below, and the minimum supply and normal manifold gas pressures are as follows:

	Supply Pressure		Manifold Pressure
	MAX.	MIN.	NORMAL
NATURAL GAS:	11" W.C.	5" W.C.	4" W.C. (SEE RATING PLATE)
L.P. GAS:	14" W.C.	11" W.C.	10" W.C.

Refer to pressure noted on the label affixed to the front of the water heater. Consult your local gas company or gas supplier if correction is necessary.

EMERGENCY SHUTDOWN INSTRUCTIONS

Should the water heater be subjected to flood, fire, or other unusual condition, turn off gas at manual shut-off valve and water inlet valve to heater. Refer to figure 5. Do not place water heater in operation again until it has been thoroughly checked by qualified personnel.

TAMPERING

Tampering with the thermostat, gas valve, igniter control, or temperature and pressure relief valve is DANGEROUS and voids all warranties. Only qualified personnel should service these components



WARNING

Should overheating occur or the gas fail to shut off, turn off the manual gas control valve to appliance, and call a qualified service person to check for the cause

MAINTENANCE

BURN AND PILOT MAINTENANCE

At least every 3 months, visually check main burner and pilot flames. Observation of the gas flame should show the burner flame to be a soft blue with the suggestion of slight yellow tips. It is to be noted that the flame of a light color may not be a carbonizing flame.

Carbonizing flames are to be avoided and can be determined by wiping the tip of the combustion chamber when the flames is extinguished and the combustion chamber has cooled to determine if any carbon or soot has been deposited. If the burners are dirty or clogged with lint or soot, the burners can be cleaned with soap and water. If soot re-occurs, refer to common complaints, page 26 and 27.

At least every 3 months a visual inspection should be made of the venting system. You should look for:

- . obstructions which could cause improper venting.
- . damage or deterioration which could cause improper venting or leakage of combustion products.

PILOT AND MAIN BURNER



Figure 13

WATER HEATER SOUNDS

1. Possible noises due to expansion and contraction of some metal parts during periods of heat-up and cool-down do not represent harmful or dangerous conditions.
2. Sediment buildup in the tank bottom will create varying amounts of noise, and left in the tank, will cause premature tank failure.
3. Condensation causes sizzling and popping within the burner areas during heating and cooling periods and should be considered normal. See Condensation.

DRAINING

The water should be drained if being shut down during freezing temperatures. Also, periodic draining and cleaning of sediment from the tank may be necessary. See Page 19.

1. Turn gas valve knob clockwise to the OFF position.
2. Close the cold water inlet valve to the heater.
3. Open a nearby hot water faucet.
4. Open the heater drain valve.
5. If the heater is going to be shut down and drained for an extended period, the drain valve should be left open.



WARNING

THIS WATER CAN BE HOT



CAUTION

THIS WATER HEATER SHOULD NOT BE USED TO HEAT A SPA OR HOT TUB

THIS WATER HEATER IS NOT INTENDED OR SUITED FOR USE WITH A HOT TUB OR SPA AND MAY NOT BE USED FOR THIS PURPOSE

SERVICE MUST BE PERFORMED BY A QUALIFIED INSTALLER, SERVICE AGENCY OR GAS SUPPLIER

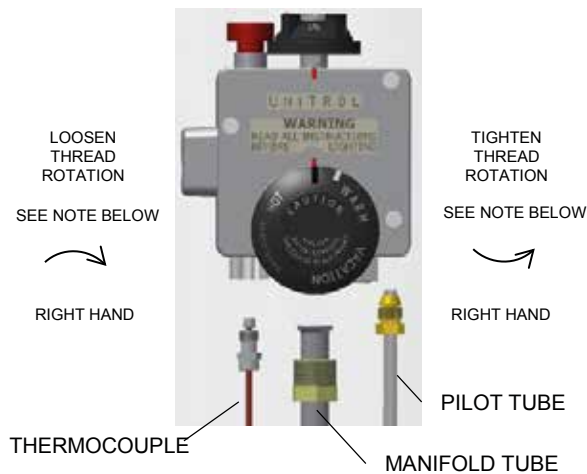

Figure 14

NOTE: L.P. (propane bottled) gas models have reverse (left handed) thread on the manifold.

DO NOT apply any thread sealant (pipe dope, teflon tape, etc.) to these connections.

REMOVAL OF BURNER ASSEMBLY

For your safety the following procedure should be performed by qualified service personnel or someone familiar with gas appliances, as it involves disconnection of gas piping and leak testing.

1. Turn gas control knob clockwise to "OFF" position (page ?).
2. Open outer and inner doors.
3. Disconnect the thermocouple, pilot tube and manifold tube at the thermostat (figure 14). Note that the propane (LP Gas) manifold has left hand thread rotation.
4. Pull the burner toward the front until the holding bracket slides out of the slot in the bottom pan. If the burner is dirty or clogged it can be cleaned with soap and water.

REPLACING THE BURNER ASSEMBLY

1. Insert the burner assembly into the opening in the bottom pan and slide toward the rear so that the burner holding bracket slides into the slot in the bottom pan.
2. The manifold tube will now line up to the thermostat connection.
3. Reconnect the manifold tube and pilot tube. Do not cross thread these fittings (figure 14). Note that the propane (LP Gas) manifold has left hand thread rotation.
4. Reconnect the thermocouple. The thermocouple nut should be started and turned all the way in by hand. An additional one-quarter turn with a 3/8" open end wrench will be sufficient to set the lockwasher (figure 14). CAUTION: OVERTIGHTENING MAY DAMAGE THE THERMOCOUPLE OR THERMOSTAT.
5. Follow OPERATING INSTRUCTIONS to relight water heater.
6. Check for gas leaks with soap and water solution or liquid detergent. Bubble forming indicates a leak. FIX ALL LEAKS IMMEDIATELY.

DO NOT USE OPEN FLAME OR ANY KIND OF SPARK TO CHECK FOR LEAKS

THERMOCOUPLE AND/OR PILOT REPLACEMENT

1. Remove burner assembly. (See "REMOVAL OF BURNER ASSEMBLY" section).
2. Grasp the thermocouple line and moderately pull the thermocouple from the pilot burner assembly. NOTE: If for any reason the thermocouple will not disengage from the pilot bracket assembly, replace the complete pilot assembly, follow steps 4 and 5, otherwise go to next step.
3. Push replacement thermocouple through hole in pilot bracket until it snaps in place. The end of a properly installed thermocouple should extend approximately 1/4 inch past the tip of the pilot assembly (go to step 6).
4. Remove No.8-32 screw holding pilot assembly to main burner (Figure 13).
5. Re-install replacement pilot assembly to main burner making sure that it is in the right location (Figure 13).
6. Replace burner assembly (see "REPLACING THE BURNER ASSEMBLY" section).

COMMON COMPLAINTS

FOLLOWING IS A LIST OF THE MOST COMMON COMPLAINTS RELATED TO THE USE OF WATER HEATERS. MANY COMPLAINTS ARE DUE TO ITEMS NOT DIRECTLY RELATED TO THE WATER HEATER. DO NOT ATTEMPT TO SERVICE THE WATER HEATER OR PERFORM OTHER RECOMMENDATIONS ON THIS LIST UNLESS YOU ARE TRAINED AND QUALIFIED TO DO SO.

CONDITION	CAUSE	REMEDY
Burner will not ignite	No gas	Check with utility
	Dirt in gas line	Notify utility-install dirt trap in gas lines
	Pilot line clogged	Clean-check for source of trouble & correct
	Main burner line clogged	Clean-check for source of trouble & correct
	Defective thermostat	Replace with new thermostat
	Thermostat set too low	Turn temperature dial to desired temperature
	Heater installed in confined area	Provide ventilation by use of louvers in wall or duct
	Defective gas valve	Replace with new gas valve
Burner flame floats-lifts off ports	High gas pressure	Check with utility
	Orifice too large	Replace with correct orifice
	Flue clogged	Clean-check for source of trouble & correct
	Heater installed in confined area	Provide ventilation by use of louvers in wall or duct
	Cold drafts	Check source & correct
Burner flame yellow lazy	Insufficient secondary air	Clear the area near the heater
	Low gas pressure	Check with utility
	Flue clogged	Clean-check for source of trouble & correct
	Main burner line clogged	Clean-check for source of trouble & correct
	Heater installed in confined area	Provide ventilation by use of louvers in wall or duct
Burner flame too high	Insufficient secondary air	Clear the area near the heater
	Orifice too large	Replace with correct orifice
Flame burns at orifice	Low gas pressure	Check with utility
	Burner surface damaged	Replace burner
Pilot will not remain lit	Low gas pressure	Check with utility
	Defective thermostat	Replace with new thermostat
	No gas	Check with utility
	Dirt in gas lines	Notify utility-install dirt trap in gas lines
	Pilot line clogged	Clean-check for source of trouble & correct
Pilot flame too small	Low gas pressure	Check with utility
	Pilot line clogged	Clean-check for source of trouble & correct
	Pilot line not clogged	Adjust pilot

CONDITION	CAUSE	REMEDY
High operating costs	Improper calibration	Replace control valve
	Thermostat set too high	Turn temperature knob to desired temperature
	Sediment or lime in tank	Clean out sediment; Refer to page 22
	Heater too small for job	Install adequate heater
	Leaking faucets	Repair faucets
	Gas leaks	Check with utility - repair at once
	Wasted hot water	Advise customer
	Long runs of exposed piping	Insulate piping
	Hot water piping in outside wall	Insulate
Insufficient hot water	Low gas pressure	Check with utility
	Orifice too small	Replace with correct orifice
	Thermostat set too low	Turn temperature dial to desired temperature
	Heater too small for job	Install adequate heater
	Leaking faucets	Repair faucets
	Wasted hot water	Advise customer
	Long runs of exposed piping	Insulate
	Hot water piping in outside wall	Insulate
Slow water recovery	Insufficient secondary air	Clear the area near the heater
	Low gas pressure	Check with utility
	Orifice too small	Replace with correct orifice
	Thermostat set too low	Turn temperature dial to desired temperature
	Sediment or lime in tank	Clean out sediment; Refer to Page 22
	Heater too small for job	Install adequate heater
	Wasted hot water	Advise customer
Drip from relief valve	Excessive water pressure	Use pressure reducing valve
Thermostat fails to close	Defective thermostat	Replace with new thermostat
Condensation		See Page 23
Combustion Odors	Insufficient secondary air Flue clogged	Provide ventilation to heater Clean-check for source of trouble & correct
Smoking and carbon formation	Insufficient secondary air	Provide ventilation to heater
	Low gas pressure	Check with utility
	Orifice too large	Replace with correct orifice
	Flue clogged	Clean-check for source of trouble & correct
	Heater installed in confined area	Provide ventilation by use of louvers in wall or duct
Pilot flame too large	Pilot line not clogged	Adjust pilot

REPLACEMENT PARTS LIST (SEE FIGURE 15)



PARTS REPLACEMENT MUST BE PERFORMED BY A QUALIFIED INSTALLER, SERVICE AGENCY OR GAS SUPPLIER

The following parts may be ordered through your plumber, a local plumbing supply company, or direct from the factory. Parts will be shipped at prevailing prices and will be billed accordingly. Refer to warranty for company address.

IMPORTANT: When ordering replacement parts, provide model number, serial number, type of gas, item number (from the following list), part description, voltage and wattage (when applicable).

It is imperative that replacement of main burner orifices, pilot burner and gas valve be ordered for the gas type. Natural gas valves will be marked with a 5.0" w.c. manifold pressure setting (see rating plate). L.P. Gas valves will be marked with a 10.0" w.c. setting.

PART NO.	DESCRIPTION	QUANT	QUANT
		75-76 100-83	G-75 G-100
1	DRAFTHOOD	1	1
2	ANODE ROD	2	1
3	DIP TUBE	1	1
4	FLUE BAFFLE	1	1
5	P&T VALVE	1	1
6	HAND HOLE COVER JACKET	1	Not applicable
7	HAND HOLE SEAL (NOT PICTURED)	1	Not applicable
7a	HAND HOLE PLATE	1	Not applicable
8	DRAIN VALVE	1	1
9	BURNER	1	1
10	THERMOSTAT	1	1
11	MAIN BURNER MANIFOLD	1	1
12	PILOT BURNER ASSEMBLY	1	1
13	*TANK LEG THERMAL BREAK *(REQUIRED ON ALL COMBUSTIBLE FLOOR INSTALLATIONS)	1 KIT	1 KIT
14	VENTURI FOR L.P GAS BURNER.	1	1

REPLACEMENT PARTS ILLUSTRATION

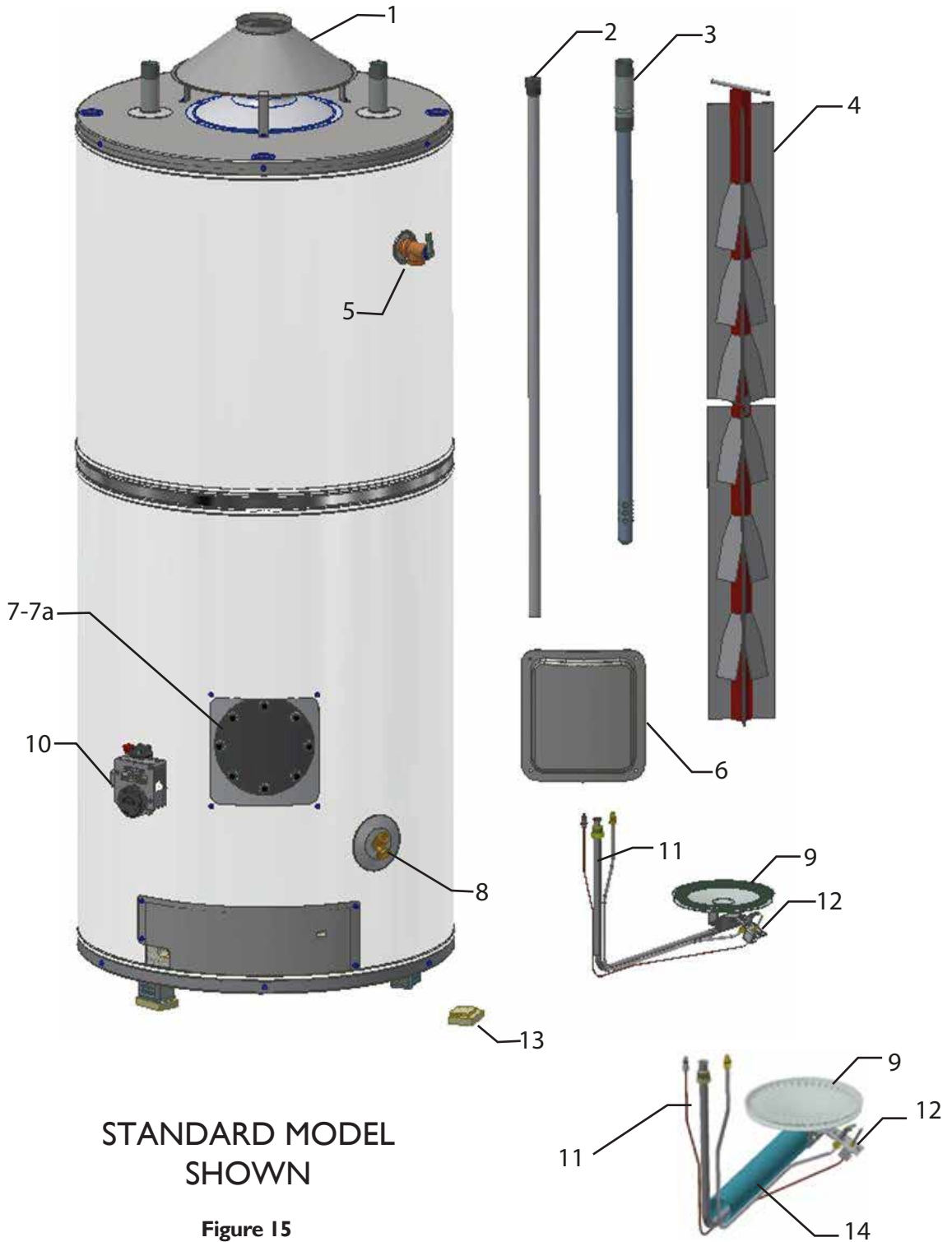

STANDARD MODEL
SHOWN

Figure 15

COMBINATION SPACE HEATING / POTABLE WATER HEATING SYSTEM

WATER (POTABLE) HEATING AND SPACE HEATING

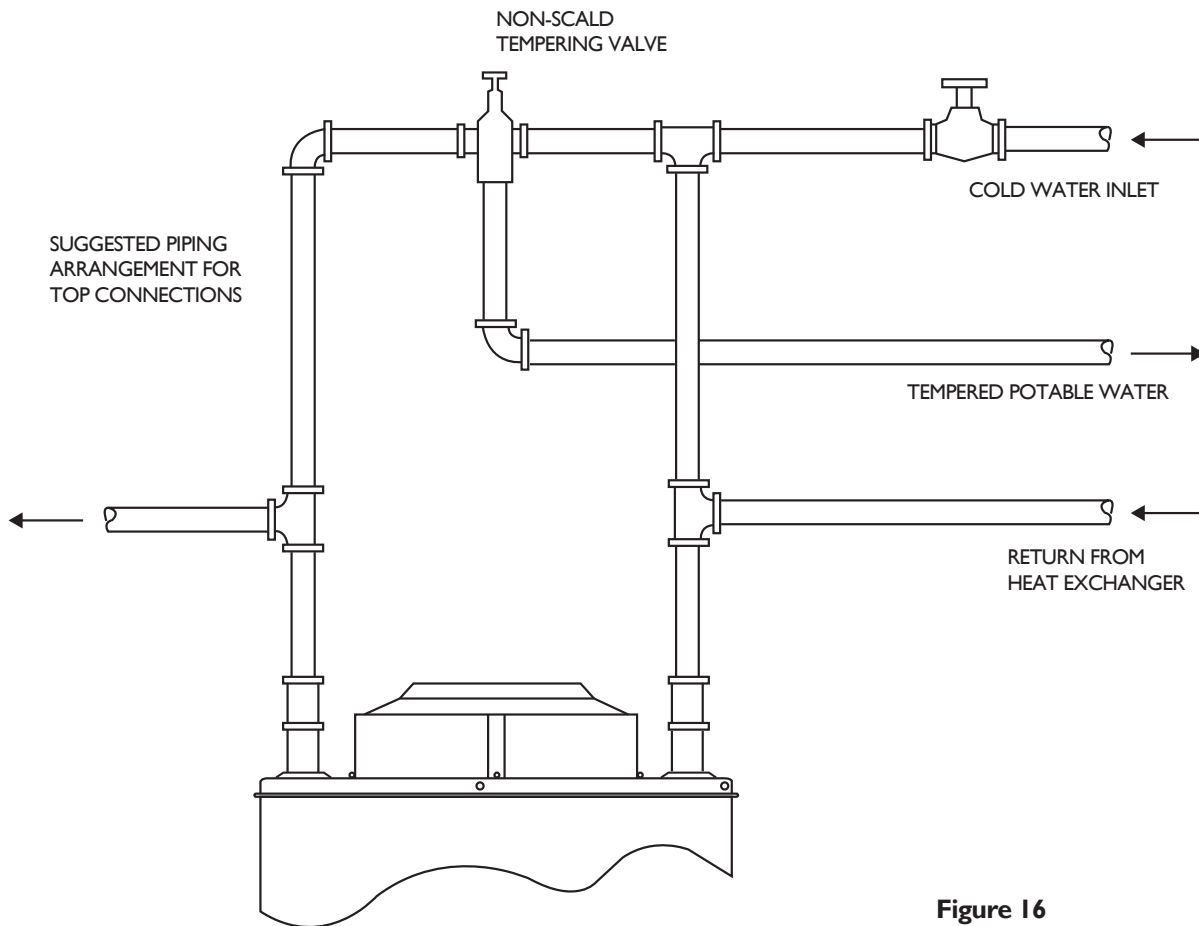
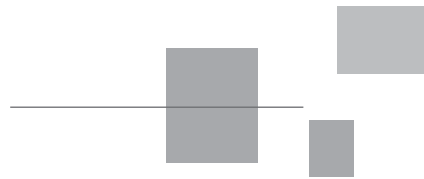

Figure 16



American Standard[®]
Water Heaters



561 New York Drive • Pomona • California 91768
Commercial Assistance (800) 900-9063 • Fax (909) 392-7302
Residential Assistance (888) 883-0788 • Fax (775) 853-7525